

MAINELEC



Dossier Technique

No OEF	: Standard
Nom CLIENT:	MAINELEC.1
TYPE	: Convoyeur a Rouleaux
AFFAIRE	:

LEROY[®]
SOMER
MOTEURS LEROY-SOMER
 16015 ANGOULEME FRANCE

A	13/01/99	MR				D	25/05/00	JP/MR	GH		modif BE	Equipement MAINELEC.1	 ANGOULEME FRANCE	Tel=(33)05 45 64 54 54 Fax=(33)05 45 64 54 00 Telex = 790244F	FOLIO I
B	18/01/99	MRMR			modif_BE	E	22/03/01	GX			modif ref.				37.9.00001.21.A1
C	21/06/99	/AA			mod_06/99	F	24/04/02	AA			mod_rep				
	DATE	DESSINE	VERIFIE	APPROUVE	No de CT		DATE	DESSINE	VERIFIE	APPROUVE	No de CT				

SOMMAIRE

No FOLIO	DESIGNATION	REPERE				CREAT. A	MODIF. B	MODIF. C	MODIF. D	MODIF. E	MODIF. F
1	PRINCIPE					13/01/99	25/05/00				
2	TELECOMMANDE					13/01/99	25/05/00	24/04/02			
3	TELECOMMANDE					13/01/99	25/05/00				
4	TELECOMMANDE					13/01/99	25/05/00				
5	BORNIER					13/01/99	18/01/99	25/05/00	24/04/02		
6	IMPLANTATION ARMOIRE					13/01/99	25/05/00				
7	PERCAGE COFFRET					18/01/99	25/05/00				

A	13/01/99	MR				D	25/05/00	JP/MR	GH		modif BE	Equipement MAINELEC.1 37.9.00001.21.A1	 ANGOULEME FRANCE	Tel=(33)05 45 64 54 54 Fax=(33)05 45 64 54 00 Tlx= 790244 F	FOLIO II
B	18/01/99	MRMR			modif_BE	E	22/03/01	GX			modif ref.				DD 57145
C	21/06/99	/AA			mod_06/99	F	24/04/02	AA							
	DATE	DESSINE	VERIFIE	APPROUVE	No de CT		DATE	DESSINE	VERIFIE	APPROUVE	No de CT				

NOMENCLATURE

No FOLIO	DESIGNATION	REPERE				CREAT. A	MODIF. B	MODIF. C	MODIF. D	MODIF. E	MODIF. F
1	NOMENCLATURE					25/05/00	22/03/01				
2	NOMENCLATURE					25/05/00	22/03/01				
3	NOMENCLATURE					25/05/00	22/03/01				
4	NOMENCLATURE					25/05/00	22/03/01				
5	NOMENCLATURE					25/05/00	22/03/01				

A	13/01/99	MR				D	25/05/00	JP/MR	GH		modif BE	Equipement MAINELEC.1 37.9.00001.21.A1	 ANGOULEME FRANCE	Tel=(33)05 45 64 54 54 Fax=(33)05 45 64 54 00 Tlx= 790244 F	FOLIO III
B	18/01/99	MRMR			modif_BE	E	22/03/01	GX		modif ref.					
C	21/06/99	/AA			mod_06/99	F	24/04/02	AA							
	DATE	DESSINE	VERIFIE	APPROUVE	No de CT		DATE	DESSINE	VERIFIE	APPROUVE	No de CT				DD 57145

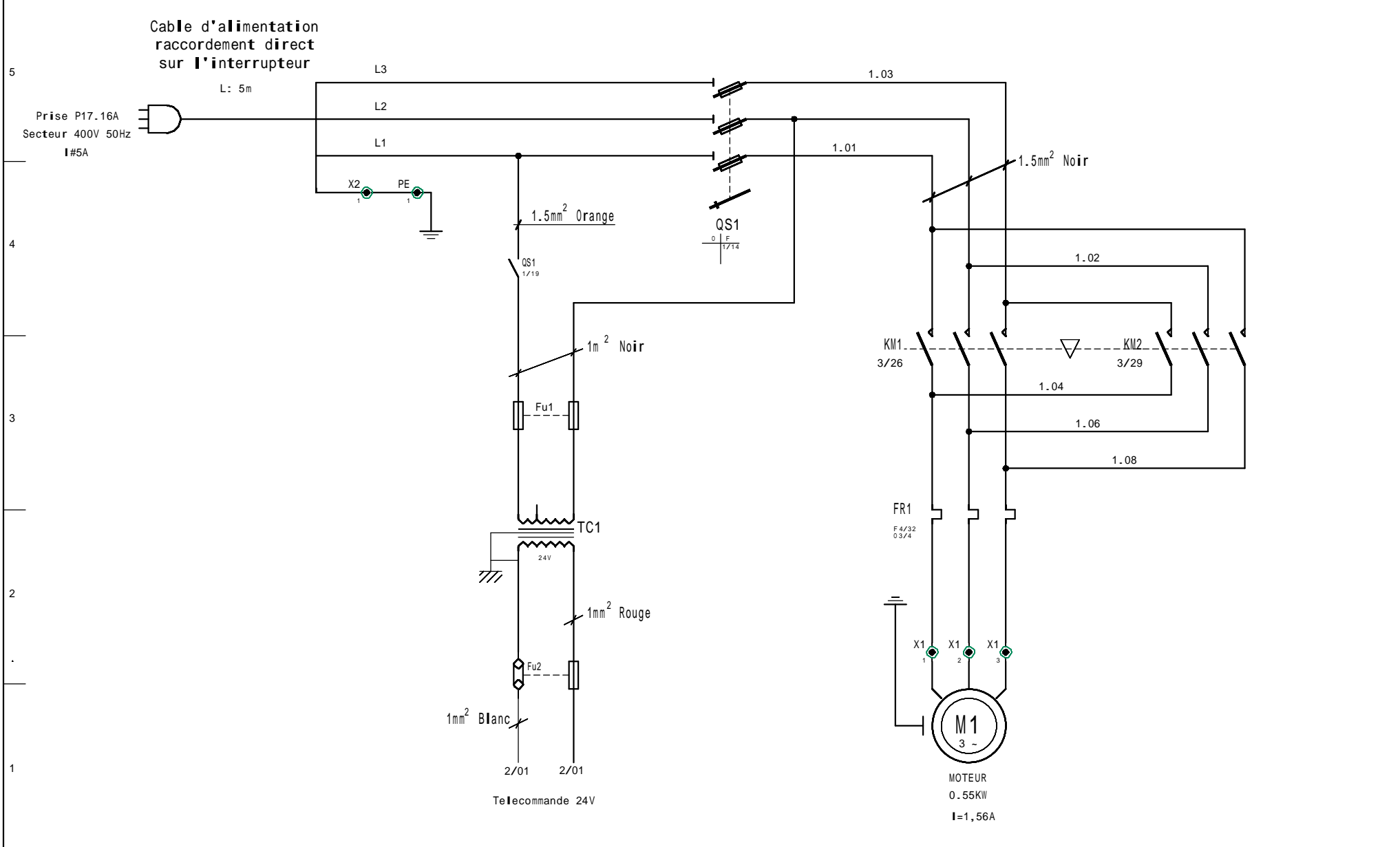

A	13/01/99	MR	D			Ref	37.9.00001.21.A1	Equipement	MAINELEC.1	 Tel=(33)05 45 64 54 54 Fax=(33)05 45 64 54 00 Telex = 790244 F ANGOULEME FRANCE	FOLIO	1
B	25/05/00	MR	E			Designation	PRINCIPE	Local.	armoire		DD	57145
C			F			DATE	VISA	DATE	VISA			

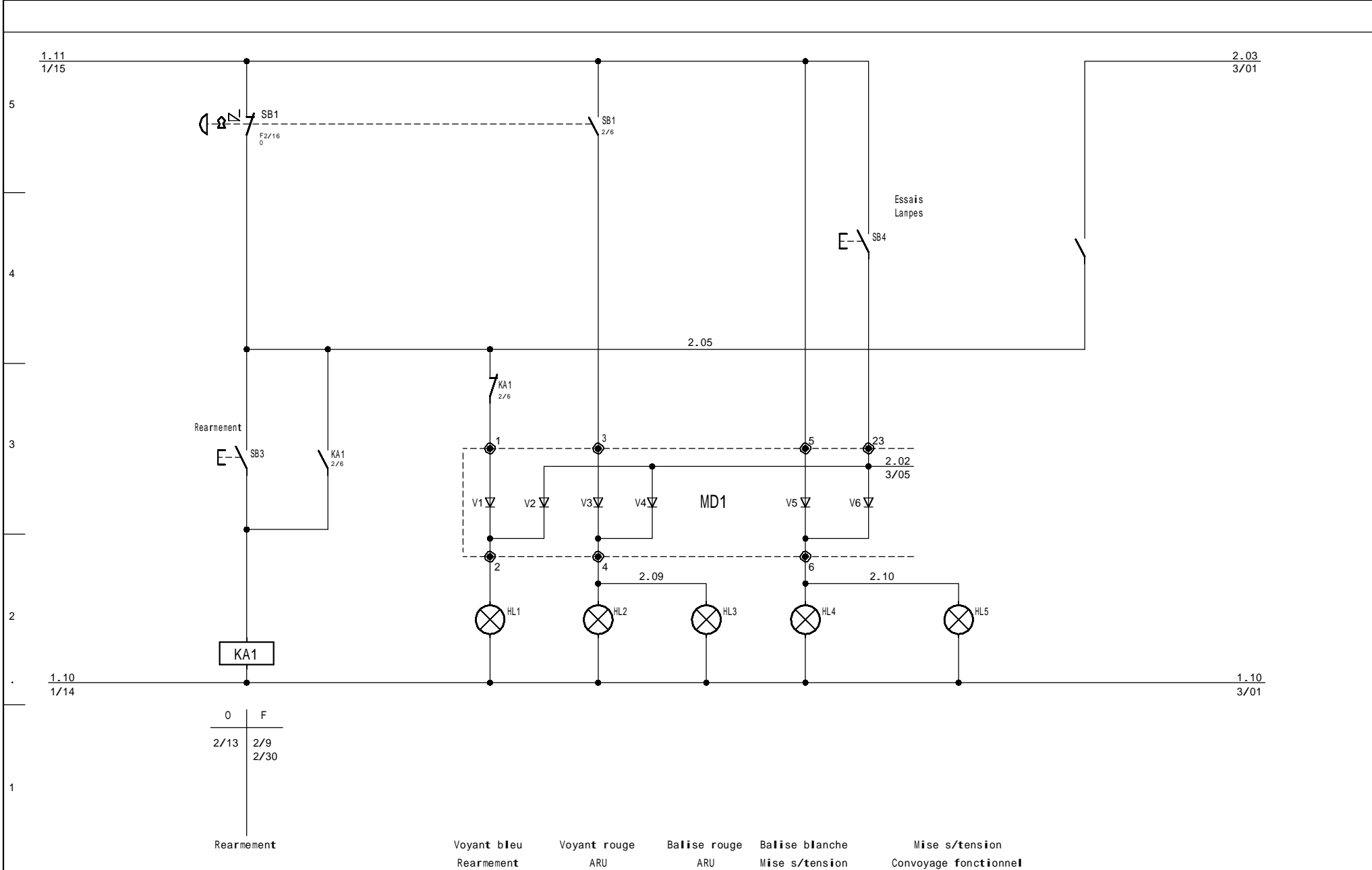

A	13/01/99	MR	D			Ref 37.9.00001.21.A1	Equipment MAINELEC.1	 Tel=(33)05 45 64 54 54 Fax=(33)05 45 64 54 00 Telex = 790244 F	FOLIO 2		
B	25/05/00	MR	E						Designation TELECOMMANDE	Local. armoire	ANGOULEME FRANCE
C	24/04/02	AA	F								
	DATE	VISA		DATE	VISA						

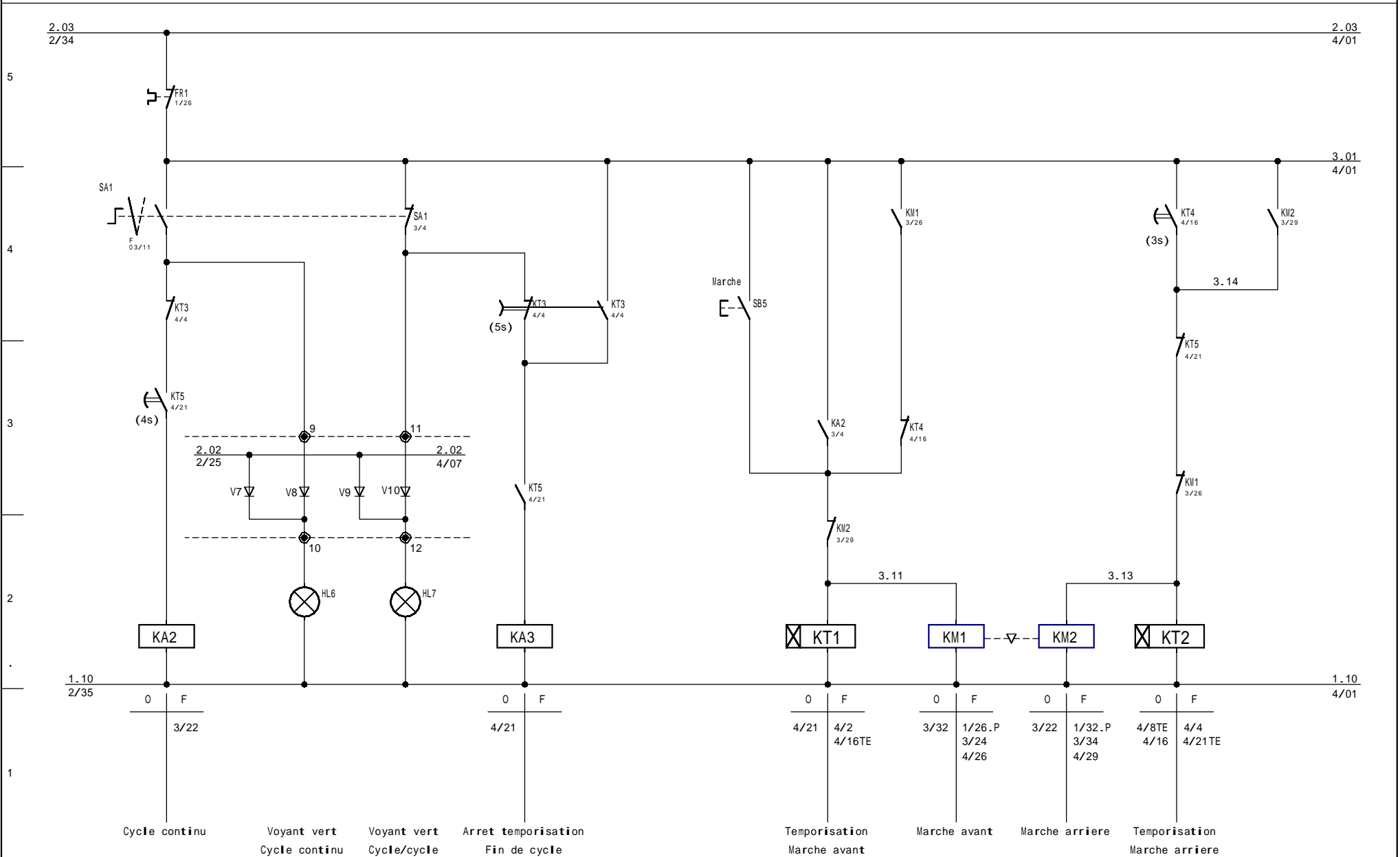

A	13/01/99	MR	D			Ref 37.9.00001.21.A1	Equipement MAINELEC.1	Tel=(33)05 45 64 54 54 Fax=(33)05 45 64 54 00 Telex = 790244 F	FOLIO 3		
B	25/05/00	MR	E								
C			F			Designation TELECOMMANDE	Local. armoire	ANGOULEME FRANCE	DD 57145		
	DATE	VISA	DATE	VISA							

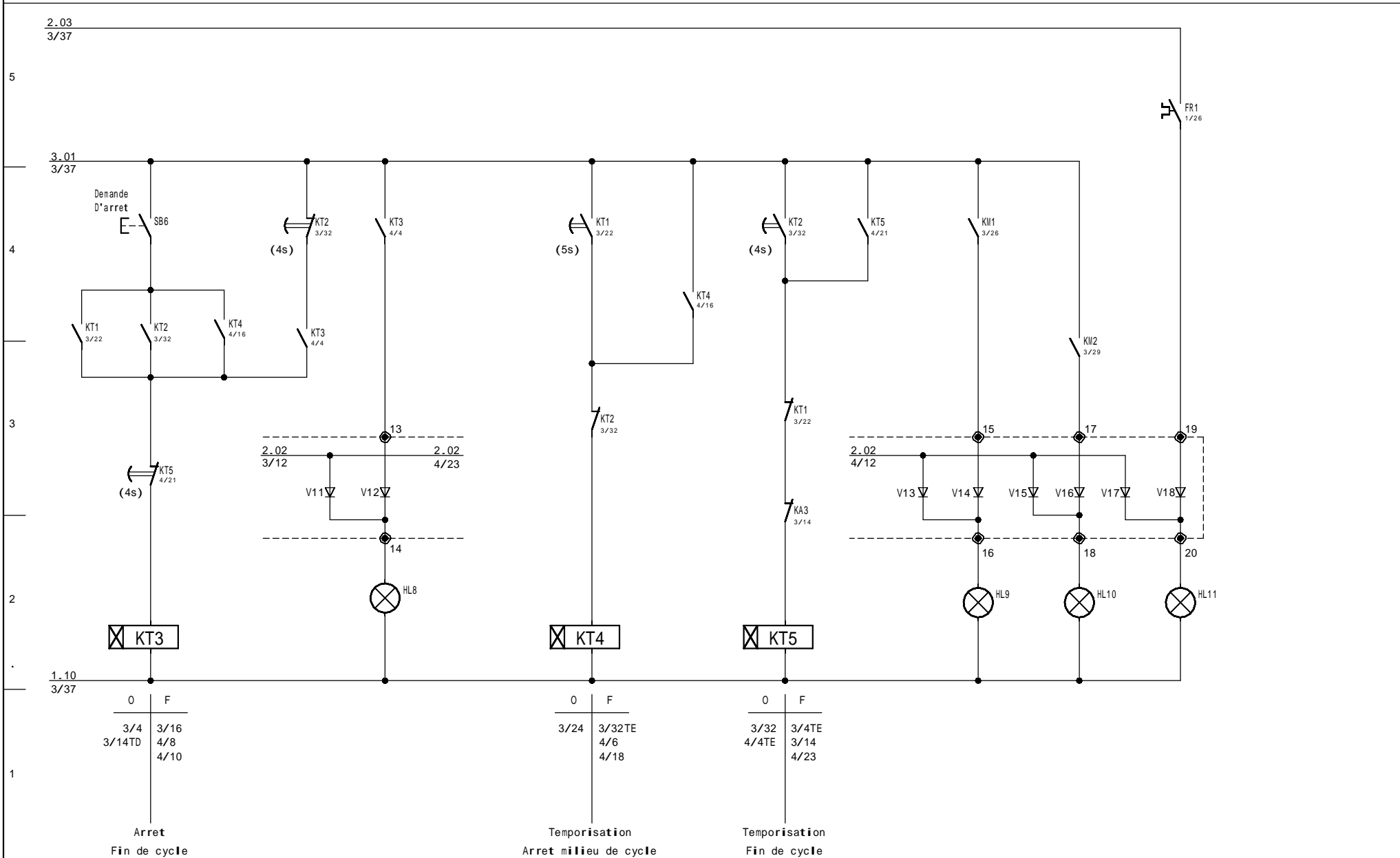

A	13/01/99	MR	D			Ref 37.9.00001.21.A1	Equipement MAINELEC.1	Tel=(33)05 45 64 54 54 Fax=(33)05 45 64 54 00 Telex = 790244 F	FOLIO 4		
B	25/05/00	MR	E						Designation TELECOMMANDE	Local. armoire	ANGOULEME FRANCE
C			F								
	DATE	VISA		DATE	VISA						

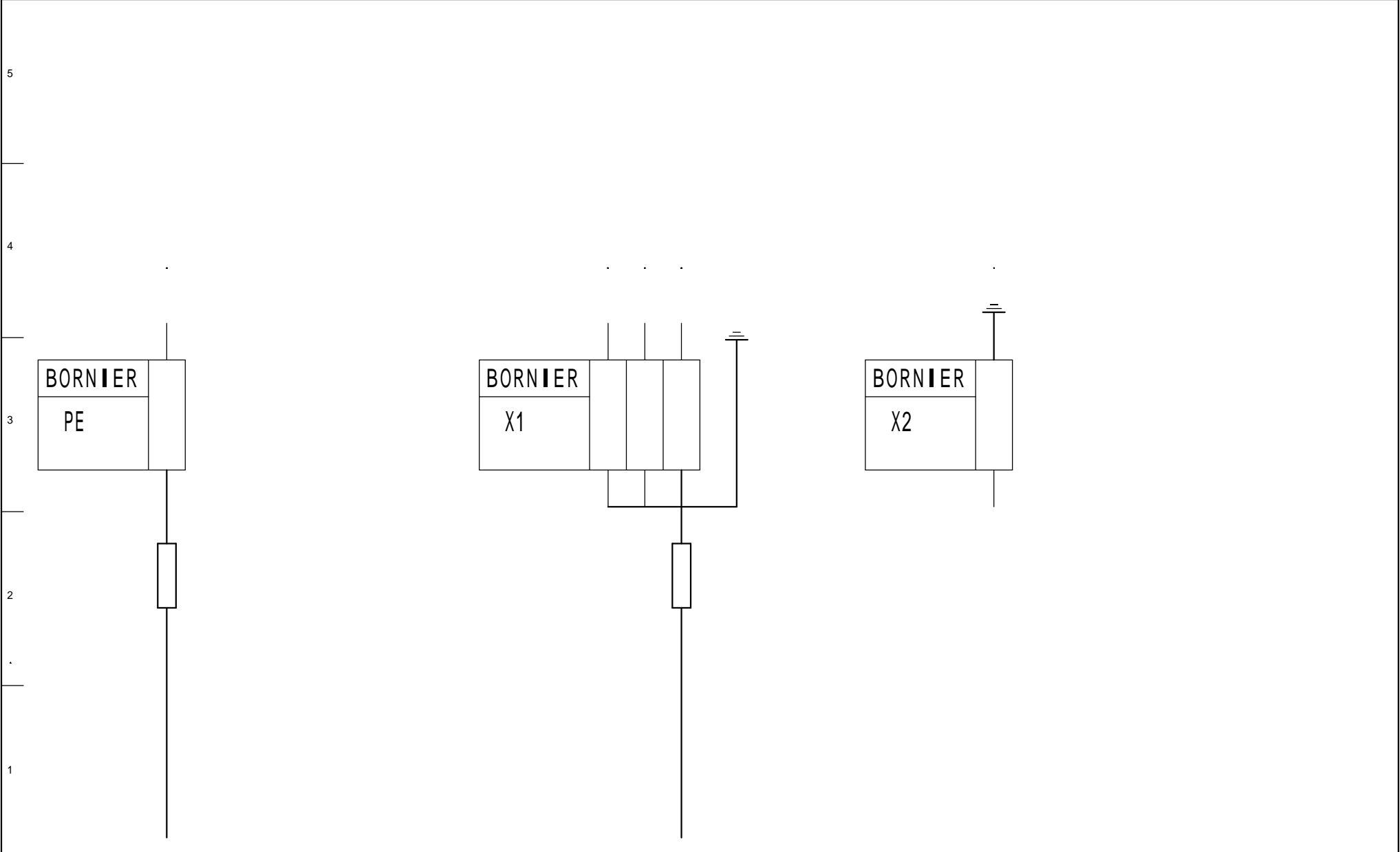

A	13/01/99	MR	D	24/04/02	AA	Ref 37.9.00001.21.A1	Equipment MAINELEC.1	 Tel=(33)05 45 64 54 54 Fax=(33)05 45 64 54 00 Telex = 790244 F ANGOULEME FRANCE	FOLIO 5		
B	18/01/99	MR	E						Designation BORNIER	Local. armoire	DD 57145
C	25/05/00	MR	F								
	DATE	VISA		DATE	VISA						

5
4
3
2
1

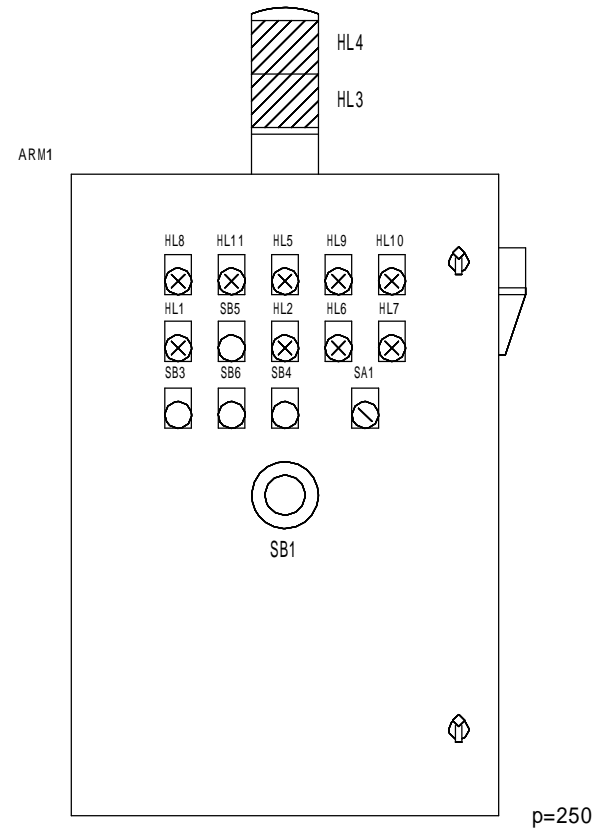
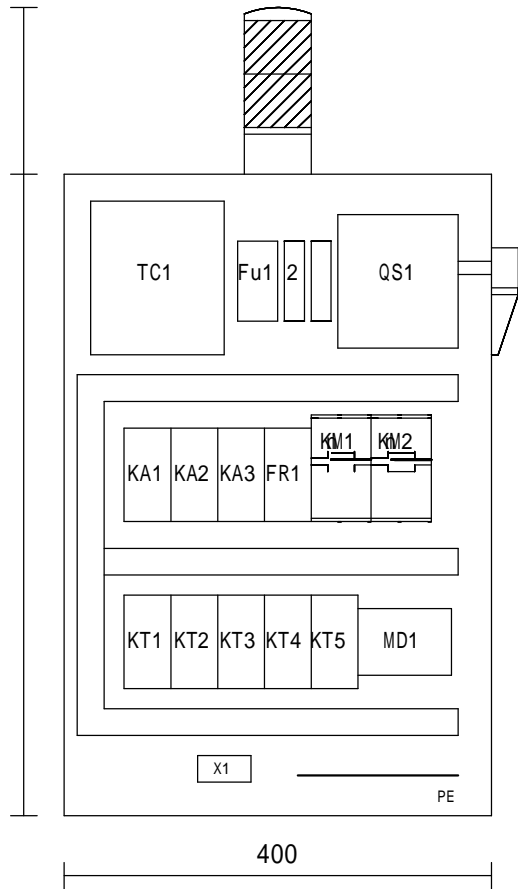

NOTA: Porte avec charnières a gauche

A	13/01/99	MR	D			Ref 37.9.00001.21.A1	Equipement MAINELEC.1	 Tel=(33)05 45 64 54 54 Fax=(33)05 45 64 54 00 Telex = 790244 F ANGOULEME FRANCE	FOLIO 6		
B	25/05/00	MR	E						Designation IMPLANTATION ARMOIRE	Local. armoire	DD 57145
C			F								
	DATE	VISA	DATE	VISA							

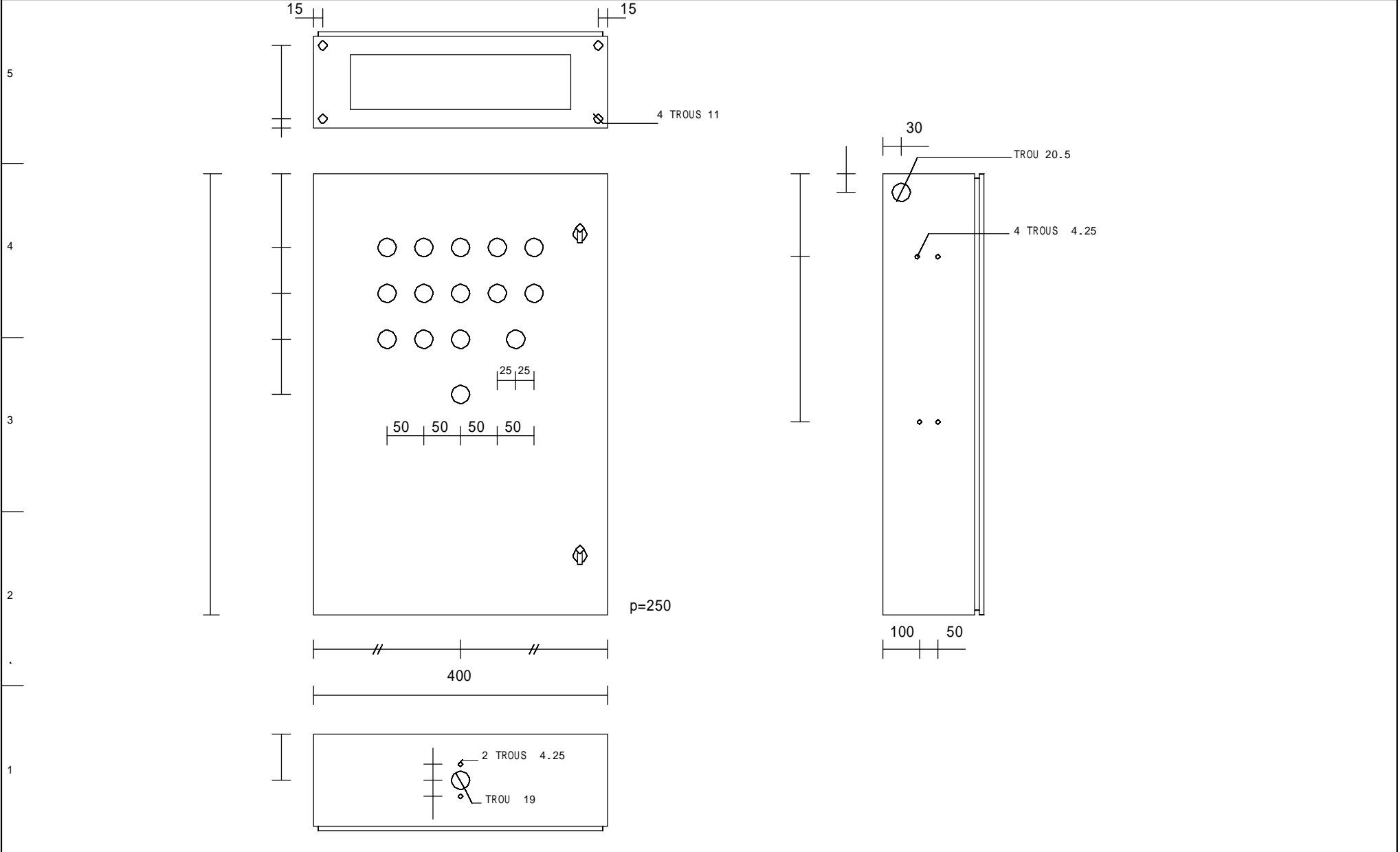

A	18/01/99	MR	D			Ref 37.9.00001.21.A1	Equipment MAINELEC.1	 Tel=(33)05 45 64 54 54 Fax=(33)05 45 64 54 00 Telex = 790244 F	FOLIO 7		
B	25/05/00	MR	E						Designation PERCAGE COFFRET	Local. armoire	ANGOULEME FRANCE
C			F								
	DATE	VISA		DATE	VISA						

CODE-ARTICLE	LOCALISATION	REPERE	Q	DESIGNATION				REFERENCE	Fournisseur
COF.060.CM.003	armoire	ARM1	1	coffret metal	IP559	400 600 250	gris RAL7032	53027	sarel
JOI.013.PP.000	armoire	ARM1	1	presse etoupe	PG13 Rep 12		plastique	241302	capri
JOI.013.PE.005	armoire	ARM1	1	ecrou plastique	PG13 Rep 12			261370	capri
PDE.100.PT.008	armoire	ARM1	2	Equerre support cable	RAL9005		Toile peinte	3790001040A	somepa
COF.000.SA.013	armoire	ARM1	1	platine perforee	600x400mm			55426	sarel
PEL.001.RT.011	armoire	FR1	1	relais thermique	modele d	1A/1.7A	1o 1f	LRD06	telemecanique
PEL.000.AC.044	armoire	FR1	1	bornier de montage separe			pour LRD01 a 35	LAD7B10	telemecanique
APE.032.PF.009	armoire	Fu1	1	socle 2p	type PF10	10x38	32A	Z209437P	ferraz
PEL.001.FA.000	armoire	Fu1	2	cartouche	10x38	1A	am	am_10x38_1A	ferraz
APE.032.PF.005	armoire	Fu2	1	socle 1p + N	type 05818	10x38	32A	05818	legrand
PEL.004.FG.001	armoire	Fu2	1	cartouche	10x38	4A	gf	gf_10x38_4A	ferraz
APE.100.AS.029	armoire	HL1	1	tete voyant led	affleurant	bleu	22	ZB4_BV063	telemecanique
PSI.027.ET.004	armoire	HL1	1	jeu d'etiquette	T416.FT.8091	8x27		T416.FT.8091	leroy_somer
APE.100.AC.030	armoire	HL1	1	embase fixation		22		ZB4_BZ009	telemecanique
APE.000.AS.024	armoire	HL1	1	led integree bleu	bloc lumineux	24vdc/ac		ZBV_B6	telemecanique
REP.040.PE.001	armoire	HL1	1	support	etiquette 8x27		40 30	ZBZ_32	telemecanique
APE.100.AS.027	armoire	HL2	1	tete voyant led	affleurant	rouge	22	ZB4_BV043	telemecanique
APE.100.AC.030	armoire	HL2	1	embase fixation		22		ZB4_BZ009	telemecanique
APE.000.AS.022	armoire	HL2	1	led integree rouge	bloc lumineux	24vdc/ac		ZBV_B4	telemecanique
REP.040.PE.001	armoire	HL2	1	support	etiquette 8x27		40 30	ZBZ_32	telemecanique
APE.100.AS.023	armoire	HL3	1	Element lumineux	XVA C34	rouge	<=230V	XVA-C34	telemecanique
APE.300.AS.031	armoire	HL3	1	lampe	BA15d	24V		DL1_BL024	telemecanique
APE.000.AS.015	armoire	HL3	1	embase+couvercle	balise fixe			XVAC21	telemecanique

A	25/05/00	JP/MR											
B	22/03/01	GX				Ref	37.9.00001.21.A1	Equipement	MAINELEC.1	 TeI=(33)05 45 64 54 54 Fax=(33)05 45 64 54 00 TeIex = 790244F	FOLIO	1	
IND	DATE	VISA	IND	DATE	VISA	Designation	NOMENCLATURE	Local.			DD	57145	

CODE-ARTICLE	LOCALISATION	REPERE	Q	DESIGNATION	REFERENCE	FOURNISSEUR
APE.100.AS.021	armoire	HL4	1	Element lumineux XVA C37 incolore <=230V	XVA-C37	telemecanique
APE.300.AS.031	armoire	HL4	1	lampe BA15d 24V	DL1_BL024	telemecanique
APE.100.AS.025	armoire	HL5	1	tete voyant led affleurant blanc 22	ZB4_BV013	telemecanique
APE.100.AC.030	armoire	HL5	1	embase fixation 22	ZB4_BZ009	telemecanique
APE.000.AS.020	armoire	HL5	1	led integree blanc bloc lumineux 24vdc/ac	ZBV_B1	telemecanique
REP.040.PE.001	armoire	HL5	1	support etiquette 8x27 40 30	ZBZ_32	telemecanique
APE.100.AS.026	armoire	HL6	1	tete voyant led affleurant vert 22	ZB4_BV033	telemecanique
APE.100.AC.030	armoire	HL6	1	embase fixation 22	ZB4_BZ009	telemecanique
APE.000.AS.021	armoire	HL6	1	led integree vert bloc lumineux 24vdc/ac	ZBV_B3	telemecanique
REP.040.PE.001	armoire	HL6	1	support etiquette 8x27 40 30	ZBZ_32	telemecanique
APE.100.AS.026	armoire	HL7	1	tete voyant led affleurant vert 22	ZB4_BV033	telemecanique
APE.100.AC.030	armoire	HL7	1	embase fixation 22	ZB4_BZ009	telemecanique
APE.000.AS.021	armoire	HL7	1	led integree vert bloc lumineux 24vdc/ac	ZBV_B3	telemecanique
REP.040.PE.001	armoire	HL7	1	support etiquette 8x27 40 30	ZBZ_32	telemecanique
APE.100.AS.025	armoire	HL8	1	tete voyant led affleurant blanc 22	ZB4_BV013	telemecanique
APE.100.AC.030	armoire	HL8	1	embase fixation 22	ZB4_BZ009	telemecanique
APE.000.AS.020	armoire	HL8	1	led integree blanc bloc lumineux 24vdc/ac	ZBV_B1	telemecanique
REP.040.PE.001	armoire	HL8	1	support etiquette 8x27 40 30	ZBZ_32	telemecanique
APE.100.AS.026	armoire	HL9	1	tete voyant led affleurant vert 22	ZB4_BV033	telemecanique
APE.100.AC.030	armoire	HL9	1	embase fixation 22	ZB4_BZ009	telemecanique
APE.000.AS.021	armoire	HL9	1	led integree vert bloc lumineux 24vdc/ac	ZBV_B3	telemecanique
REP.040.PE.001	armoire	HL9	1	support etiquette 8x27 40 30	ZBZ_32	telemecanique
APE.100.AS.026	armoire	HL10	1	tete voyant led affleurant vert 22	ZB4_BV033	telemecanique

A	25/05/00	JP/MR				Ref 37.9.00001.21.A1	Equipment MAINELEC.1	 Tel=(33)05 45 64 54 54 Fax=(33)05 45 64 54 00 Telex = 790244F	FOLIO 2		
B	22/03/01	GX							Designation NOMENCLATURE	Local.	DD 57145
IND	DATE	VISA	IND	DATE	VISA						

CODE-ARTICLE	LOCALISATION	REPERE	Q	DESIGNATION	REFERENCE	FOURNISSEUR
APE.100.AC.030	armoire	HL10	1	embase fixation 22	ZB4_BZ009	telemecanique
APE.000.AS.021	armoire	HL10	1	led integree vert bloc lumineux 24vdc/ac	ZBV_B3	telemecanique
REP.040.PE.001	armoire	HL10	1	support etiquette 8x27 40 30	ZBZ_32	telemecanique
APE.100.AS.028	armoire	HL11	1	tete voyant led affleurant jaune 22	ZB4_BV053	telemecanique
APE.100.AC.030	armoire	HL11	1	embase fixation 22	ZB4_BZ009	telemecanique
REP.040.PE.001	armoire	HL11	1	support etiquette 8x27 40 30	ZBZ_32	telemecanique
APE.000.AS.023	armoire	HL11	1	led integree jaune bloc lumineux 24vdc/ac	ZBV_B5	telemecanique
CPU.010.CA.030	armoire	KA1	1	relais instantane modele d 24VAC 2o 3f	CAD32B7	telemecanique
CPU.010.CA.030	armoire	KA2	1	relais instantane modele d 24VAC 2o 3f	CAD32B7	telemecanique
CPU.010.CA.030	armoire	KA3	1	relais instantane modele d 24VAC 2o 3f	CAD32B7	telemecanique
CPU.009.CI.010	armoire	KM1	1	contact. inv. 3p modele d 24VAC 1o 1f 9A	LC2D09B7	telemecanique
CPU.200.AC.099	armoire	KM1	1	bloc_contact modele d 2f	LADN20	telemecanique
	armoire	KM2	1	contacteur inverseur 3poles associe ci-dessus	LC2_INV	telemecanique
CPU.010.CA.030	armoire	KT1	1	relais instantane modele d 24VAC 2o 3f	CAD32B7	telemecanique
CPU.200.AC.108	armoire	KT1	1	bloc_tempo:trav modele d 1o 1f 0.1/30s	LADT2	telemecanique
CPU.010.CA.030	armoire	KT2	1	relais instantane modele d 24VAC 2o 3f	CAD32B7	telemecanique
CPU.200.AC.108	armoire	KT2	1	bloc_tempo:trav modele d 1o 1f 0.1/30s	LADT2	telemecanique
CPU.010.CA.030	armoire	KT3	1	relais instantane modele d 24VAC 2o 3f	CAD32B7	telemecanique
CPU.200.AC.109	armoire	KT3	1	bloc_tempo:repos modele d 1o 1f 0.1/30s	LADR2	telemecanique
CPU.010.CA.030	armoire	KT4	1	relais instantane modele d 24VAC 2o 3f	CAD32B7	telemecanique
CPU.200.AC.108	armoire	KT4	1	bloc_tempo:trav modele d 1o 1f 0.1/30s	LADT2	telemecanique
CPU.010.CA.030	armoire	KT5	1	relais instantane modele d 24VAC 2o 3f	CAD32B7	telemecanique
CPU.200.AC.108	armoire	KT5	1	bloc_tempo:trav modele d 1o 1f 0.1/30s	LADT2	telemecanique

A	25/05/00	JP/MR				Ref 37.9.00001.21.A1	Equipment MAINELEC.1	 Tel=(33)05 45 64 54 54 Fax=(33)05 45 64 54 00 Telex = 790244F	FOLIO 3		
B	22/03/01	GX							Designation NOMENCLATURE	Local.	DD 57145
IND	DATE	VISA	IND	DATE	VISA						

CODE-ARTICLE	LOCALISATION	REPERE	Q	DESIGNATION				REFERENCE	Fournisseur
CNX.012.BC.001	armoire	PE	1	barre CU rigide	trou M5	12 x 4	180A	37389	legrand
CPU.025.SE.005	armoire	QS1	1	sectionneur	tripolaire		25A	LS1D253A65	telemecanique
CPU.000.AC.008	armoire	QS1	1	exterieure				GK1AP05	telemecanique
PEL.002.FA.000	armoire	QS1	3	cartouche	10x38	2A	am Y94252	am_10x38_2A	ferraz
APE.200.AC.121	armoire	SA1	1	tete bout tourn	2 pos fixes	noir	22	ZB4_BD2	telemecanique
APE.100.AC.030	armoire	SA1	1	embase fixation			22	ZB4_BZ009	telemecanique
APE.100.AC.061	armoire	SA1	1	bloc contact 1f			22 1f	ZBE-101	telemecanique
APE.100.AC.062	armoire	SA1	1	bloc contact 1o			22 1o	ZBE-102	telemecanique
REP.040.PE.001	armoire	SA1	1	support	etiquette 8x27		40 30	ZBZ_32	telemecanique
APE.200.AC.126	armoire	SB1	1	tete bp arr urg	dever. par cle 455	rouge	infr. 22	ZB4_BS944	telemecanique
APE.100.AC.030	armoire	SB1	1	embase fixation			22	ZB4_BZ009	telemecanique
APE.100.AC.061	armoire	SB1	1	bloc contact 1f			22 1f	ZBE-101	telemecanique
APE.100.AC.062	armoire	SB1	1	bloc contact 1o			22 1o	ZBE-102	telemecanique
REP.300.ET.059	armoire	SB1	1	etiquette	ARRET D*URGENCE		22mm/60	ZBY9130	telemecanique
APE.200.AC.109	armoire	SB3	1	tete bout pouss	affleurant	sans capsu	22	ZB4_BA0	telemecanique
APE.100.AC.030	armoire	SB3	1	embase fixation			22	ZB4_BZ009	telemecanique
APE.100.AC.061	armoire	SB3	1	bloc contact 1f			22 1f	ZBE-101	telemecanique
REP.040.PE.001	armoire	SB3	1	support	etiquette 8x27		40 30	ZBZ_32	telemecanique
APE.200.AC.115	armoire	SB3	1	bp impulsion	capsule bleu		22	ZB_A6	telemecanique
APE.200.AC.109	armoire	SB4	1	tete bout pouss	affleurant	sans capsu	22	ZB4_BA0	telemecanique
APE.100.AC.030	armoire	SB4	1	embase fixation			22	ZB4_BZ009	telemecanique
APE.100.AC.061	armoire	SB4	1	bloc contact 1f			22 1f	ZBE-101	telemecanique
REP.040.PE.001	armoire	SB4	1	support	etiquette 8x27		40 30	ZBZ_32	telemecanique

A	25/05/00	JP/MR											
B	22/03/01	GX				Ref	37.9.00001.21.A1	Equipment	MAINELEC.1	 Tel=(33)05 45 64 54 54 Fax=(33)05 45 64 54 00 Telex = 790244F	FOLIO	4	
IND	DATE	VISA	IND	DATE	VISA	Designation	NOMENCLATURE	Local.				DD	57145

CODE-ARTICLE	LOCALISATION	REPERE	Q	DESIGNATION				REFERENCE	Fournisseur
APE.200.AC.115	armoire	SB4	1	bp impulsion	capsule bleu	22		ZB_A6	telemechanique
APE.200.AC.109	armoire	SB5	1	tete bout pouss	affleurant	sans capsu	22	ZB4_BA0	telemechanique
APE.100.AC.030	armoire	SB5	1	embase fixation		22		ZB4_BZ009	telemechanique
APE.100.AC.061	armoire	SB5	1	bloc contact 1f		22	1f	ZBE-101	telemechanique
REP.040.PE.001	armoire	SB5	1	support	etiquette 8x27		40 30	ZBZ_32	telemechanique
APE.200.AC.110	armoire	SB5	1	bp impulsion	capsule blanche	22		ZB_A1	telemechanique
APE.200.AC.109	armoire	SB6	1	tete bout pouss	affleurant	sans capsu	22	ZB4_BA0	telemechanique
APE.100.AC.030	armoire	SB6	1	embase fixation		22		ZB4_BZ009	telemechanique
APE.100.AC.061	armoire	SB6	1	bloc contact 1f		22	1f	ZBE-101	telemechanique
REP.040.PE.001	armoire	SB6	1	support	etiquette 8x27		40 30	ZBZ_32	telemechanique
APE.200.AC.111	armoire	SB6	1	bp impulsion	capsule noire	22		ZB_A2	telemechanique
TRF.100.MA.003	armoire	TC1	1	transfo_mono	EN60742	P=230-400V	S=2X24V 100VA	TRF100MA003	coelmo
CNX.004.BC.000	armoire	X1	1	bloc_jonction	M4/6.10R	bloc de 10	30A	115.367.22/10	entrelec
CNX.006.BC.001	armoire	X2	1	borne_terre	M6/8.P	vert/jaune		165.114.17	entrelec
CEI.001.IS.204	armoire	CABLE1	5	cable 4x1.5mm2	H07RNF	Lg:1m		H07RNF.4x1.5	cablerie
FIX.012.CE.003	armoire	CABLE1	1	collier d'arret		d: 9.9/11.9		SHC26	richco
CEI.001.IS.204	armoire	CABLE2	2	cable 4x1.5mm2	H07RNF	Lg:1m		H07RNF.4x1.5	cablerie
CNX.001.CP.005	armoire	CABLE2	4	cosse pre-isole	1.5mm2	d=5		RSP7105A5-1	stocko
FIX.012.CE.003	armoire	CABLE2	1	collier d'arret		d: 9.9/11.9		SHC26	richco
CEN.006.TR.001	armoire	CABLE3	1	tresse masse ronde nu		6mm2 0.20m		s=6mm2	sct
CNX.010.CD.000	armoire	CABLE3	2	cosse nu	10mm2	d=6		10-6CT	mecatrac
ESC.001.MD.004	armoire	MD1	1	Module a diodes	22 diodes	anode commun		EMD24	prat
CNX.016.PI.031	ext	XP1	1	fiche male P17		3P+T	400V 16A	57428	legrand

A	25/05/00	JP/MR																	
B	22/03/01	GX																	
IND	DATE	VISA	IND	DATE	VISA	Designation	NOMENCLATURE	Local.											

Ref 37.9.00001.21.A1

Equipment MAINELEC.1



Tel=(33)05 45 64 54 54
 Fax=(33)05 45 64 54 00
 Telex = 790244F
 ANGOULEME FRANCE

FOLIO 5

DD 57145