

CONDITIONNEUSE COLLECTIVE

SAVONICC

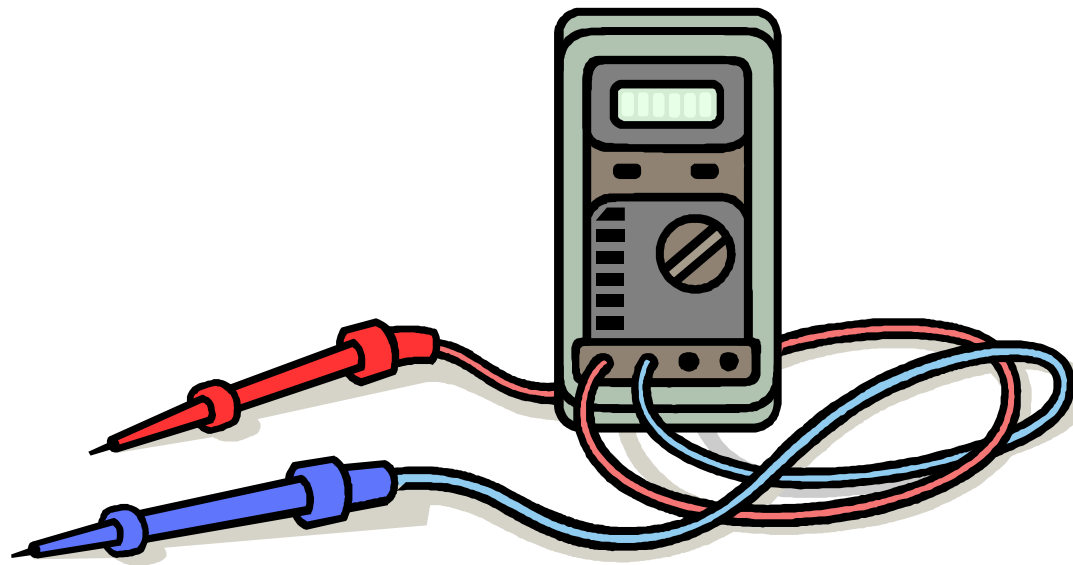

DOSSIER TECHNIQUE ELECTRIQUE





CLIENT :

CONDITIONNEUSE DE SAVON

DESSINE PAR: ELSY			
VERIFIE PAR: ELSY			
DATE D'IMPRESSION : 19/12/2008	A	19/12/2008	CREATION
AFFAIRE N°: E08-623	INDICE	DATE	MODIFICATION
DOSSIER ELECTRIQUE			FOLIO 00
			◀ 00 01 ▶

CE DOCUMENT EST NOTRE PROPRIETE. IL EST REMIS A TITRE CONFIDENTIEL. IL NE DOIT PAS ETRE REPRODUIT OU COMMUNIQUE A DES TIERS SANS NOTRE AUTORISATION ECRITE

Schémas ELECTRIQUE

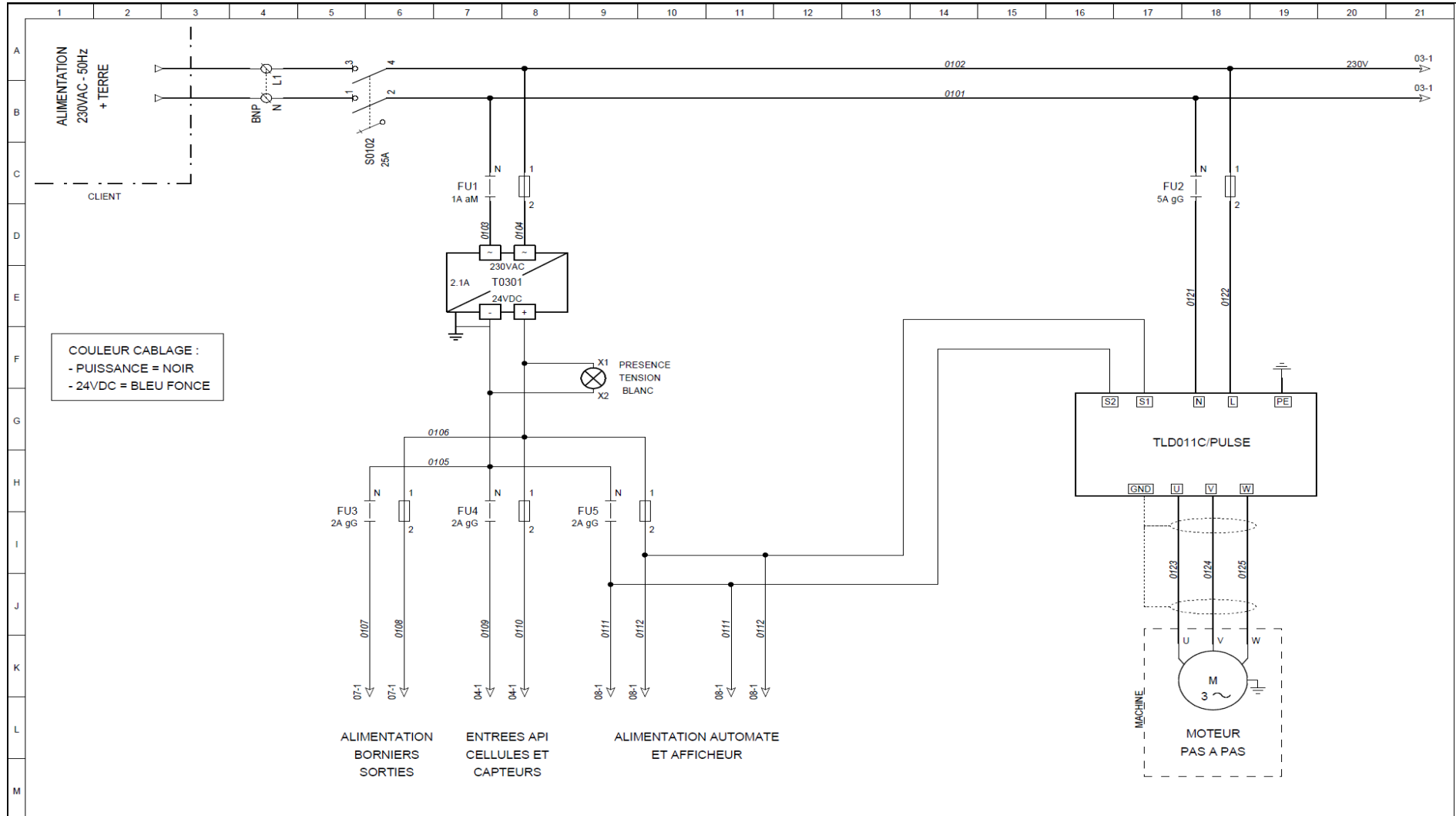

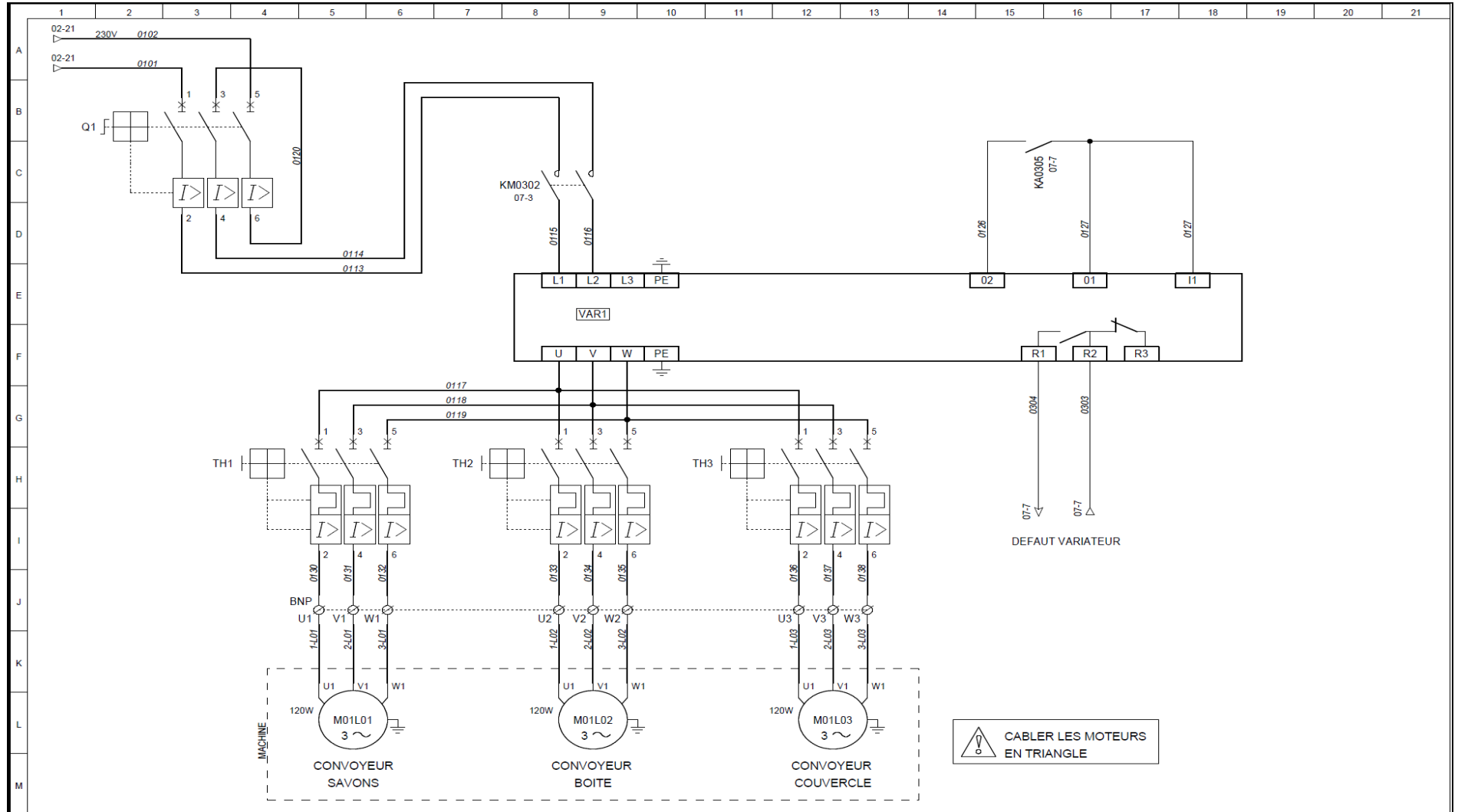

⚠ CABLER LES MOTEURS
 EN TRIANGLE

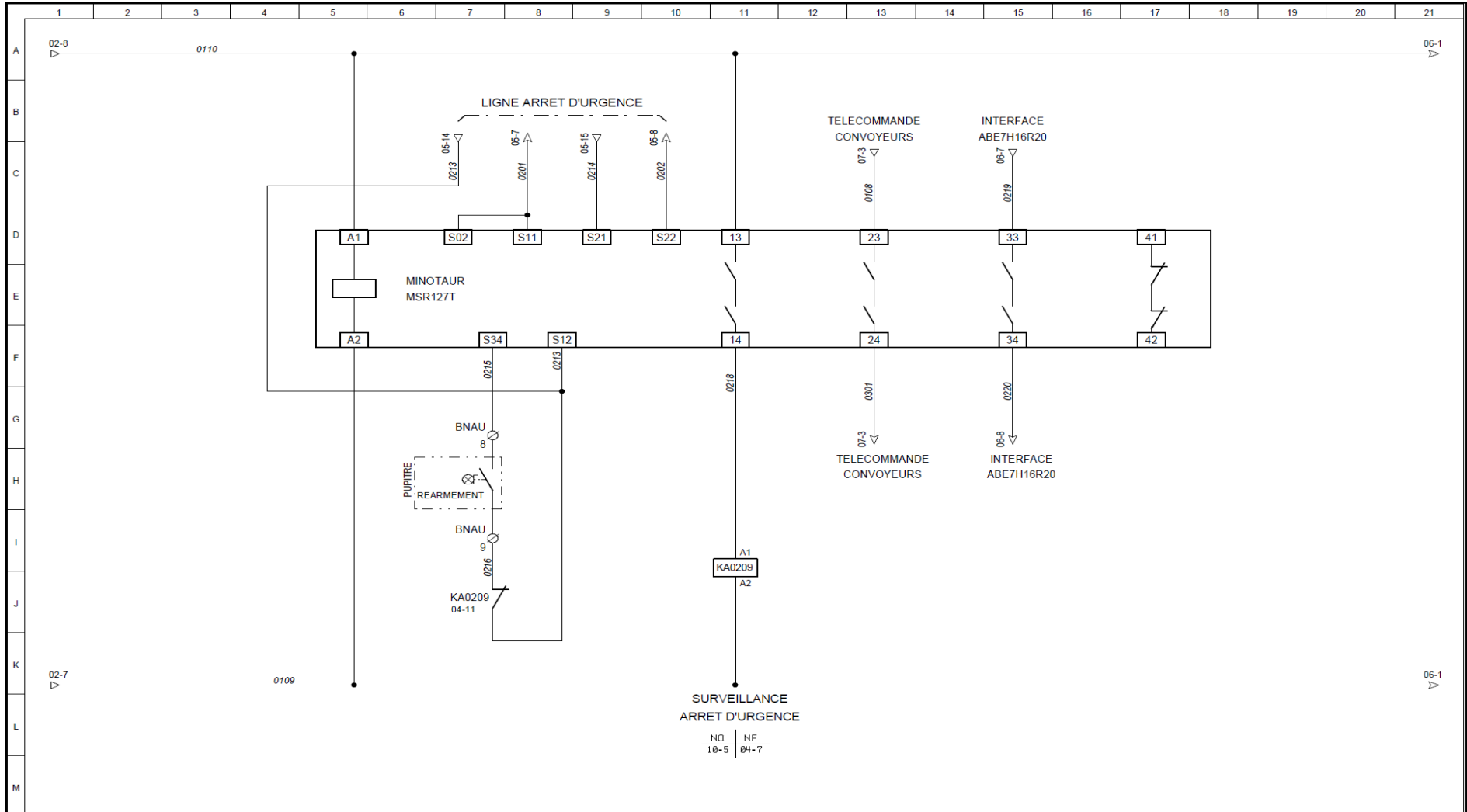

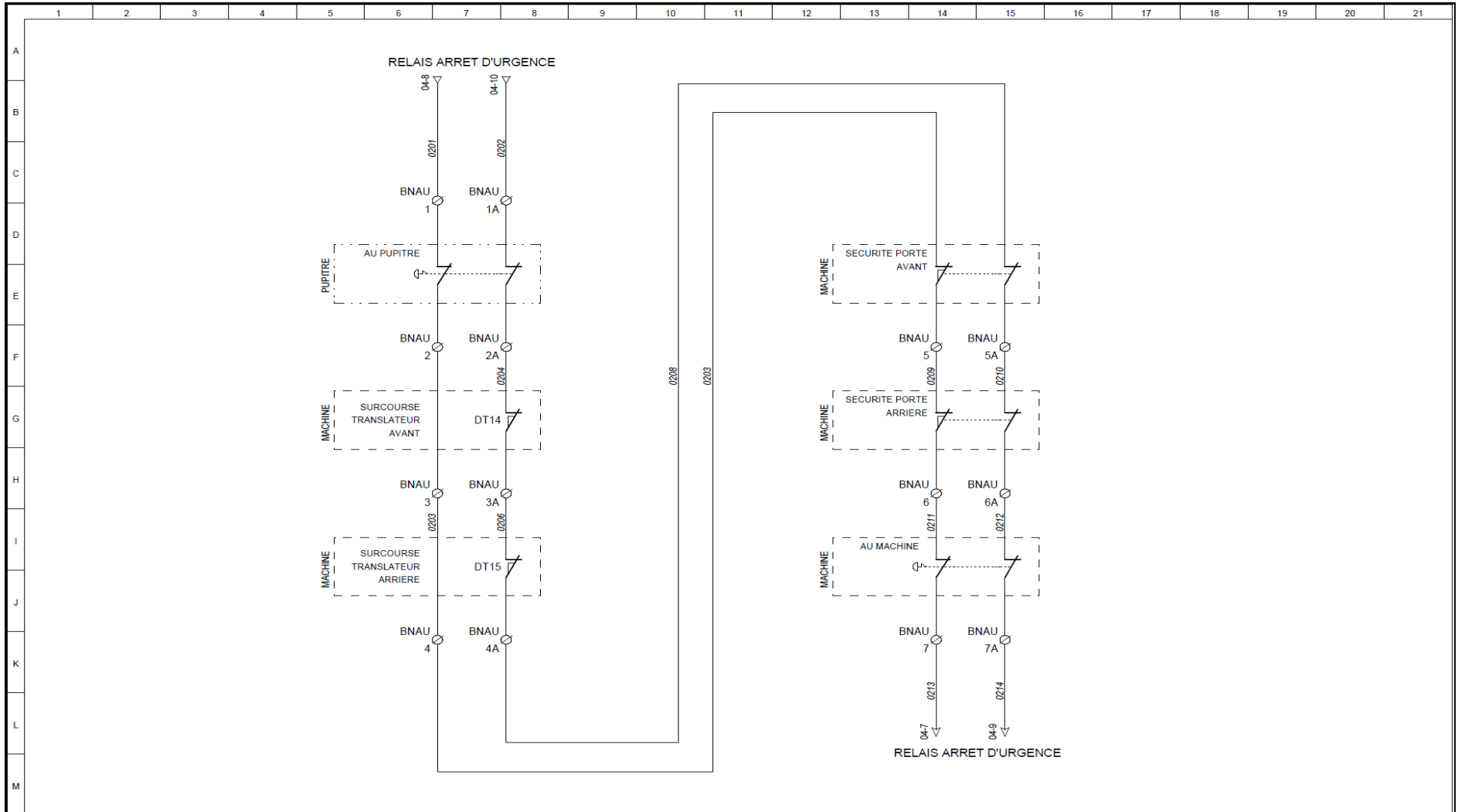

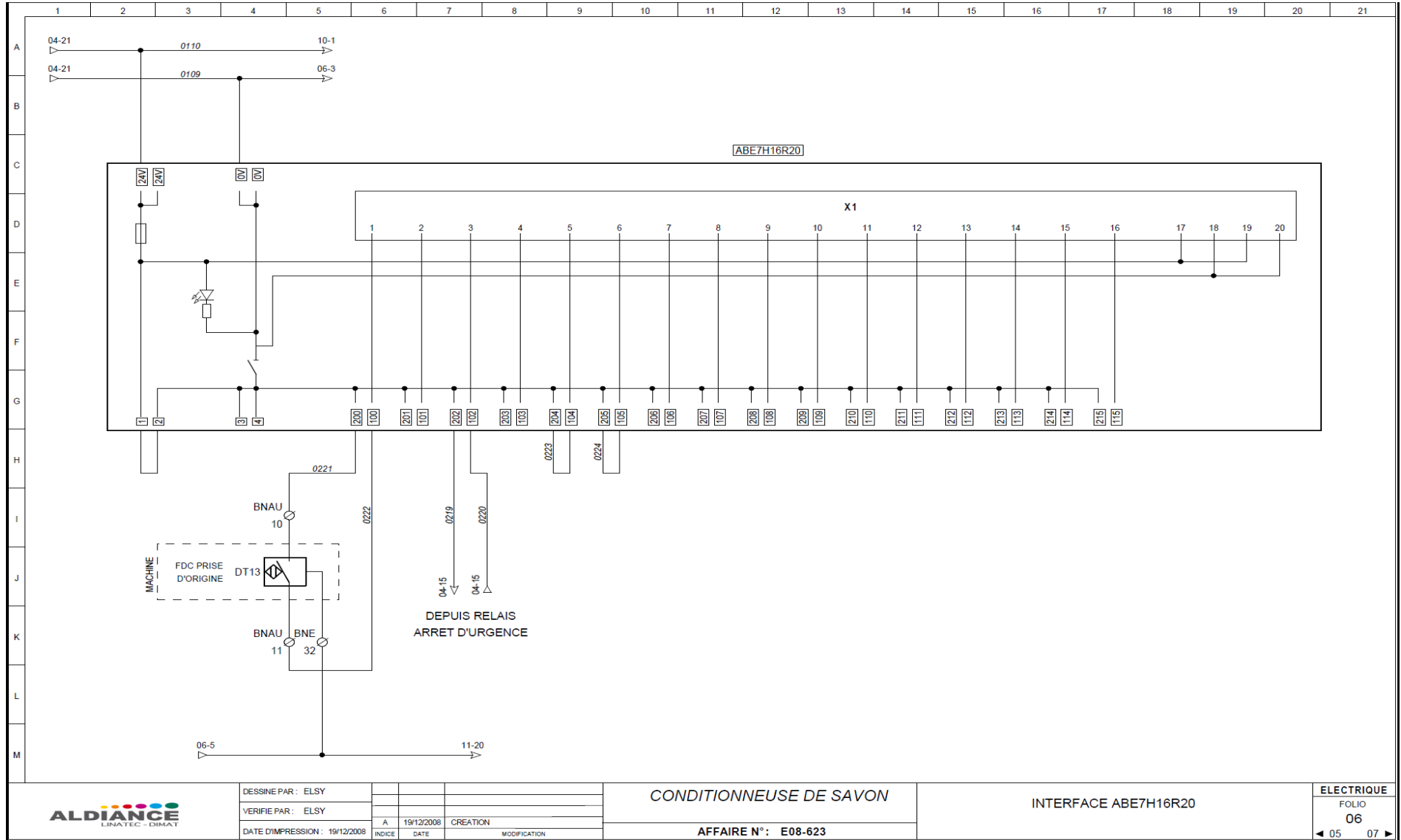

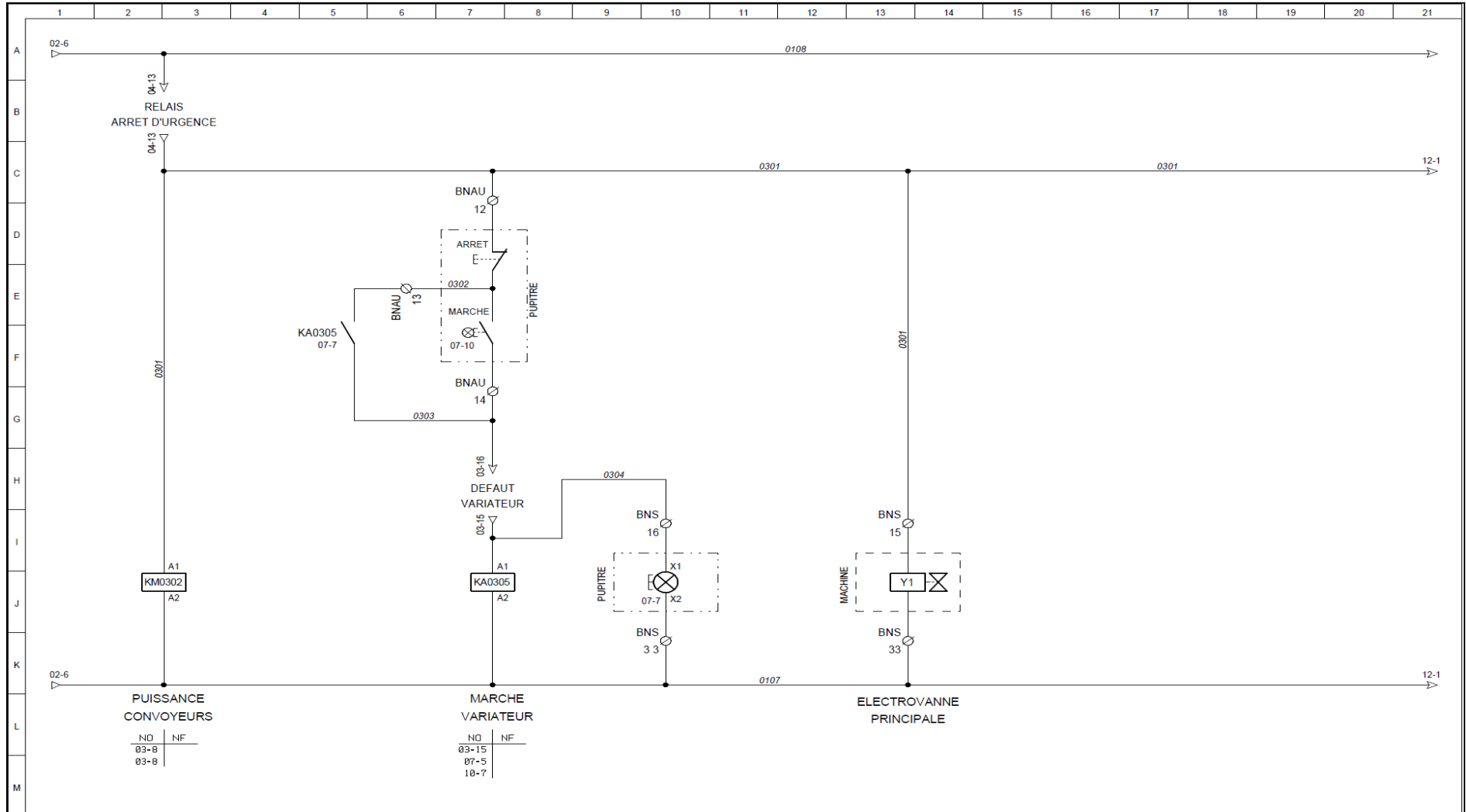

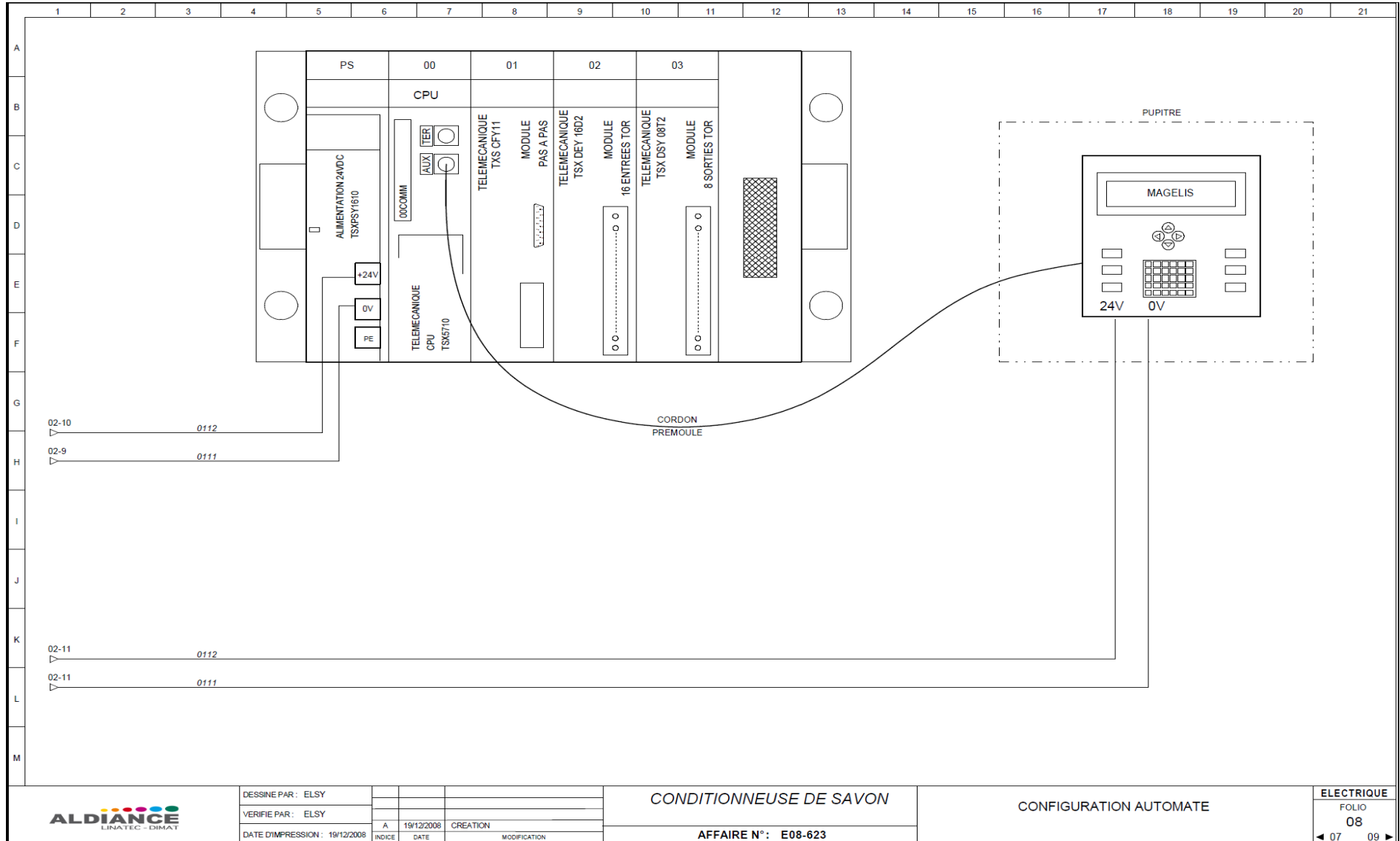

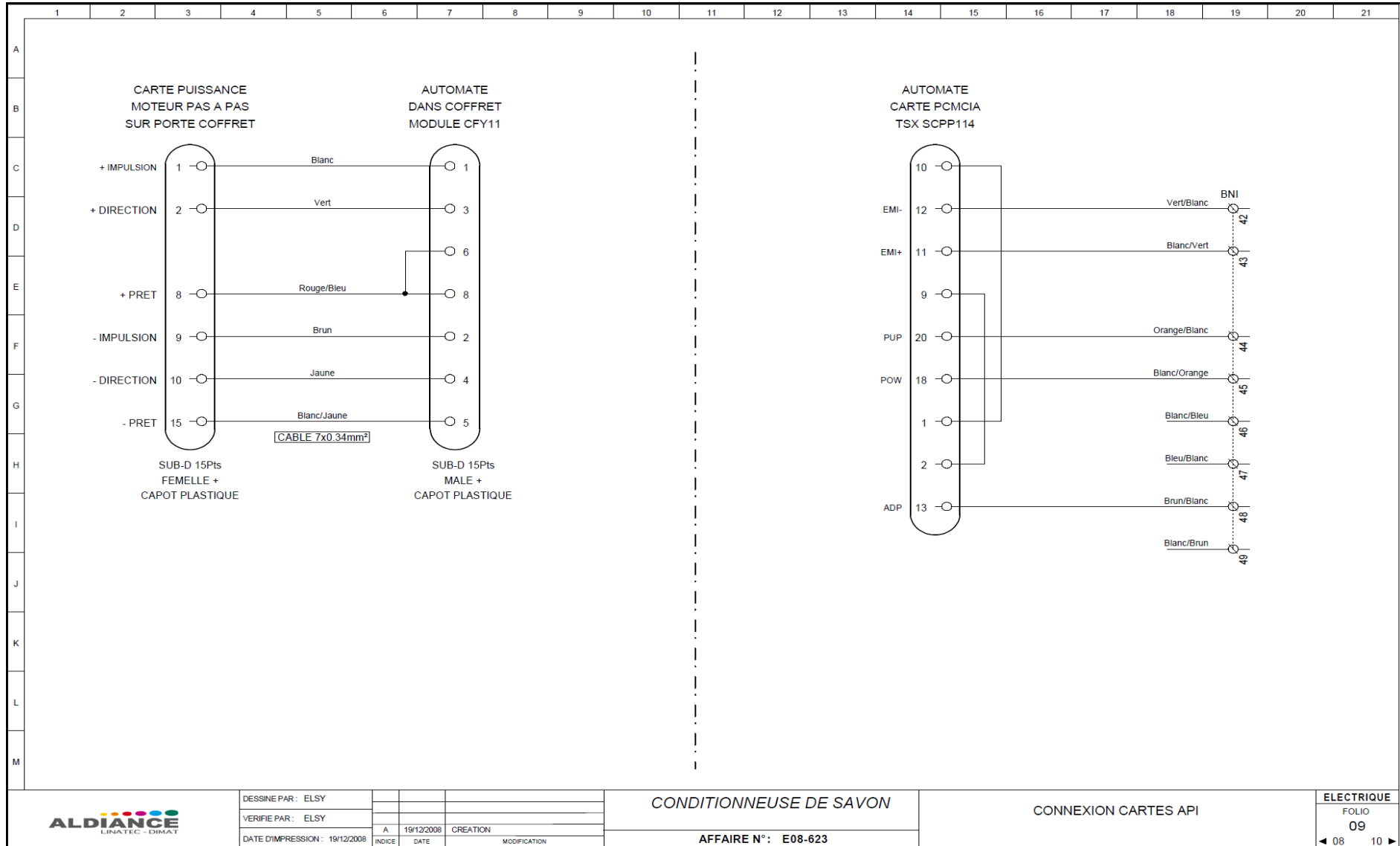

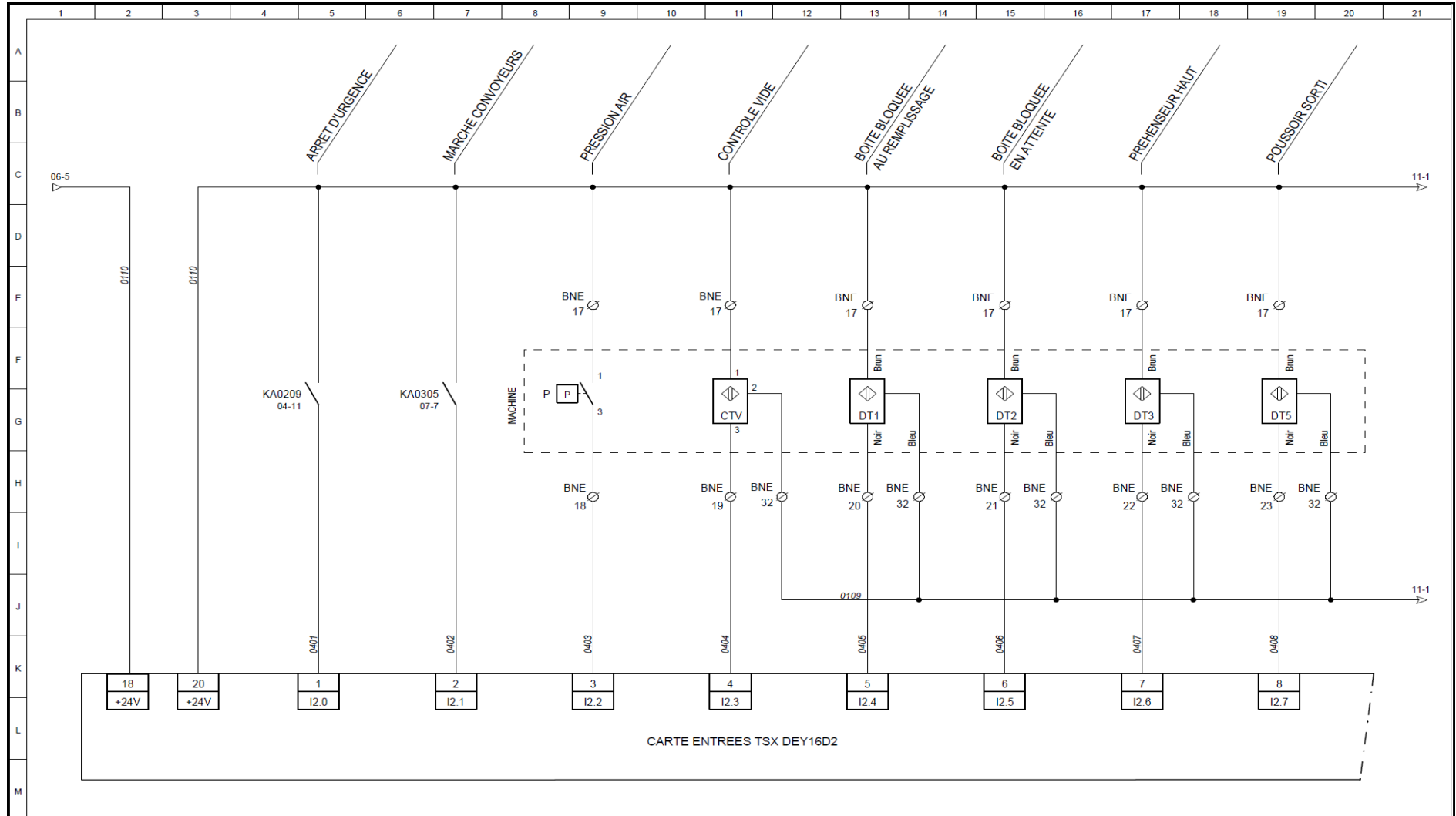

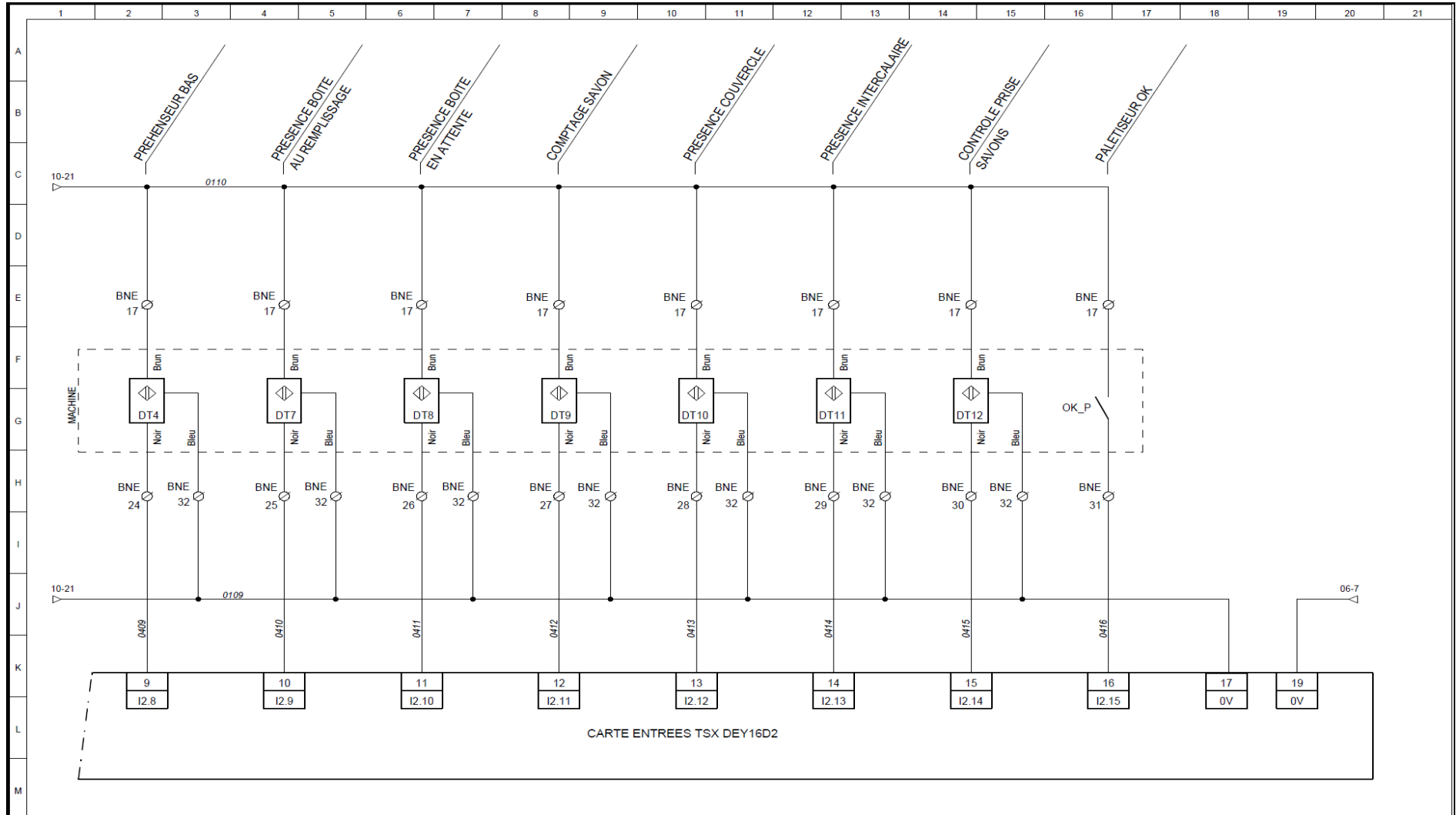

CARTE ENTREES TSX DEY16D2

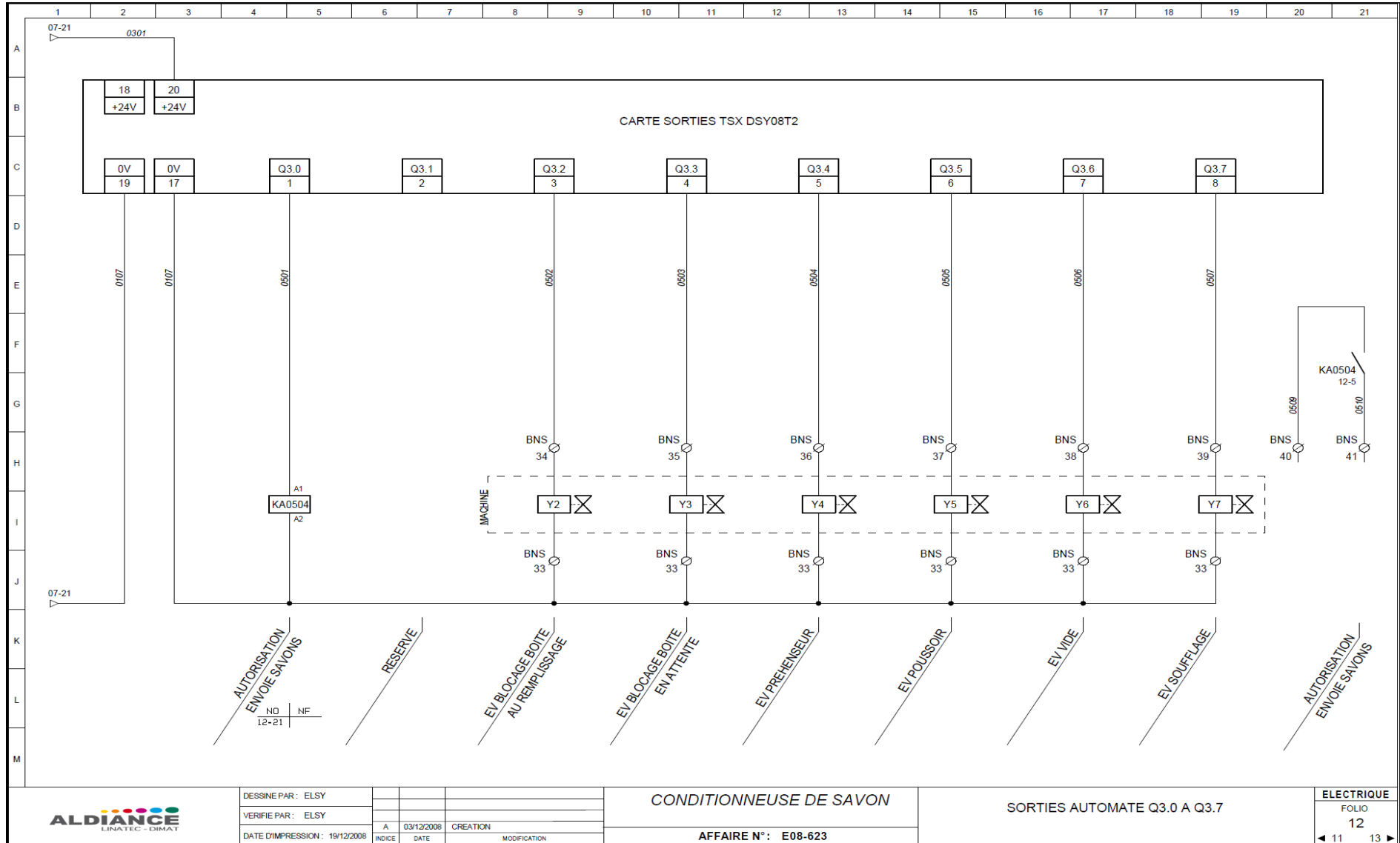

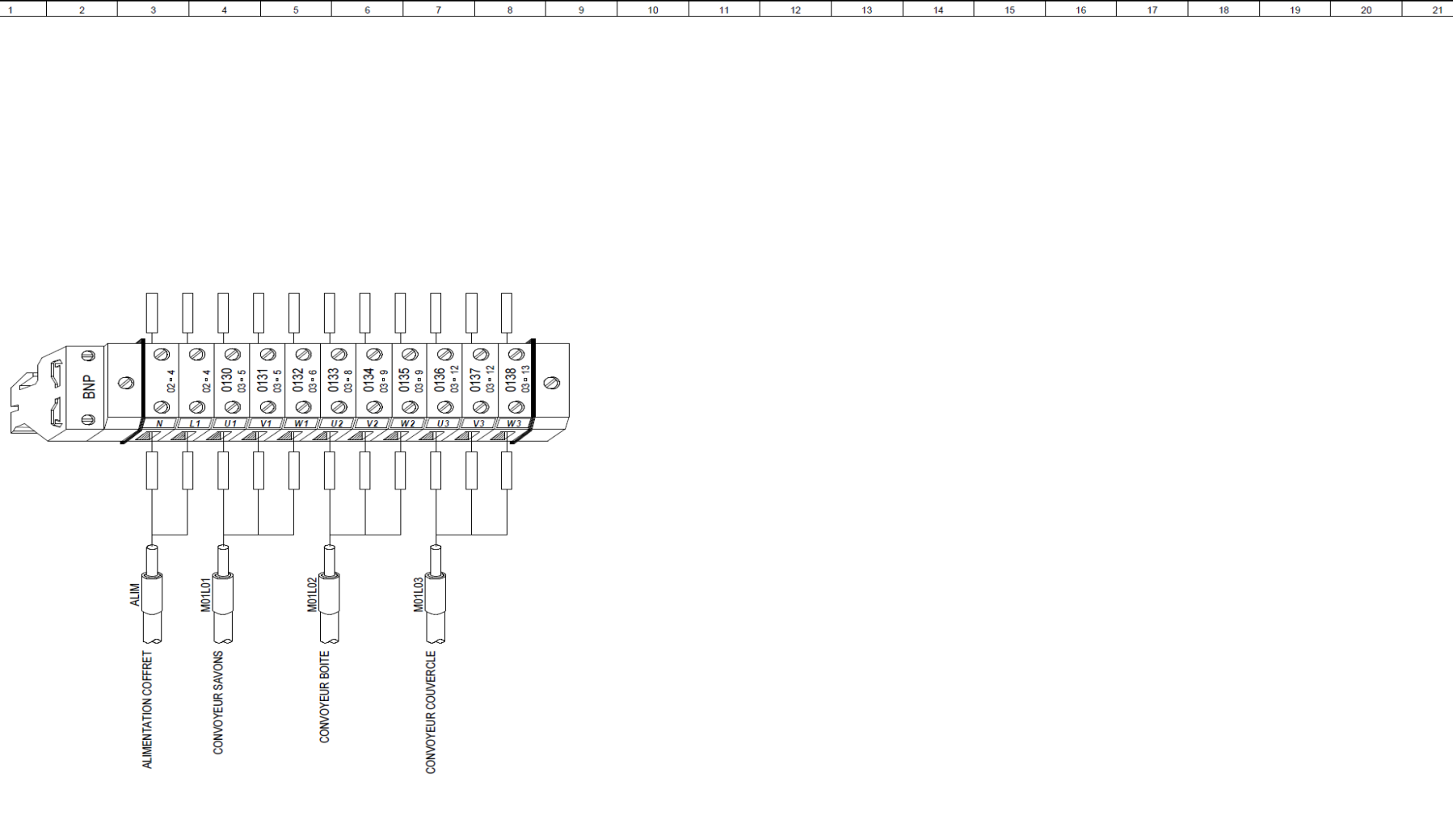

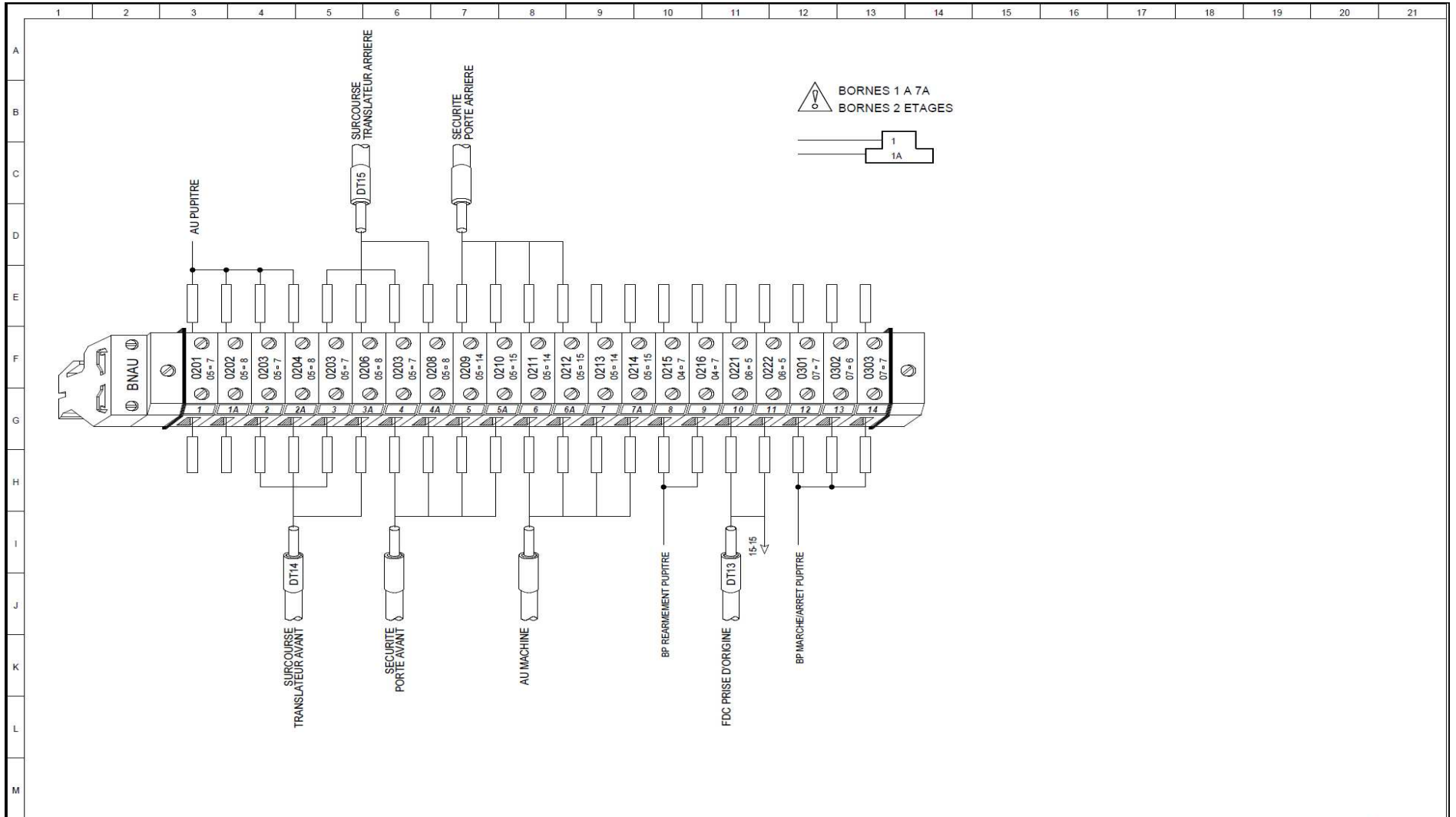

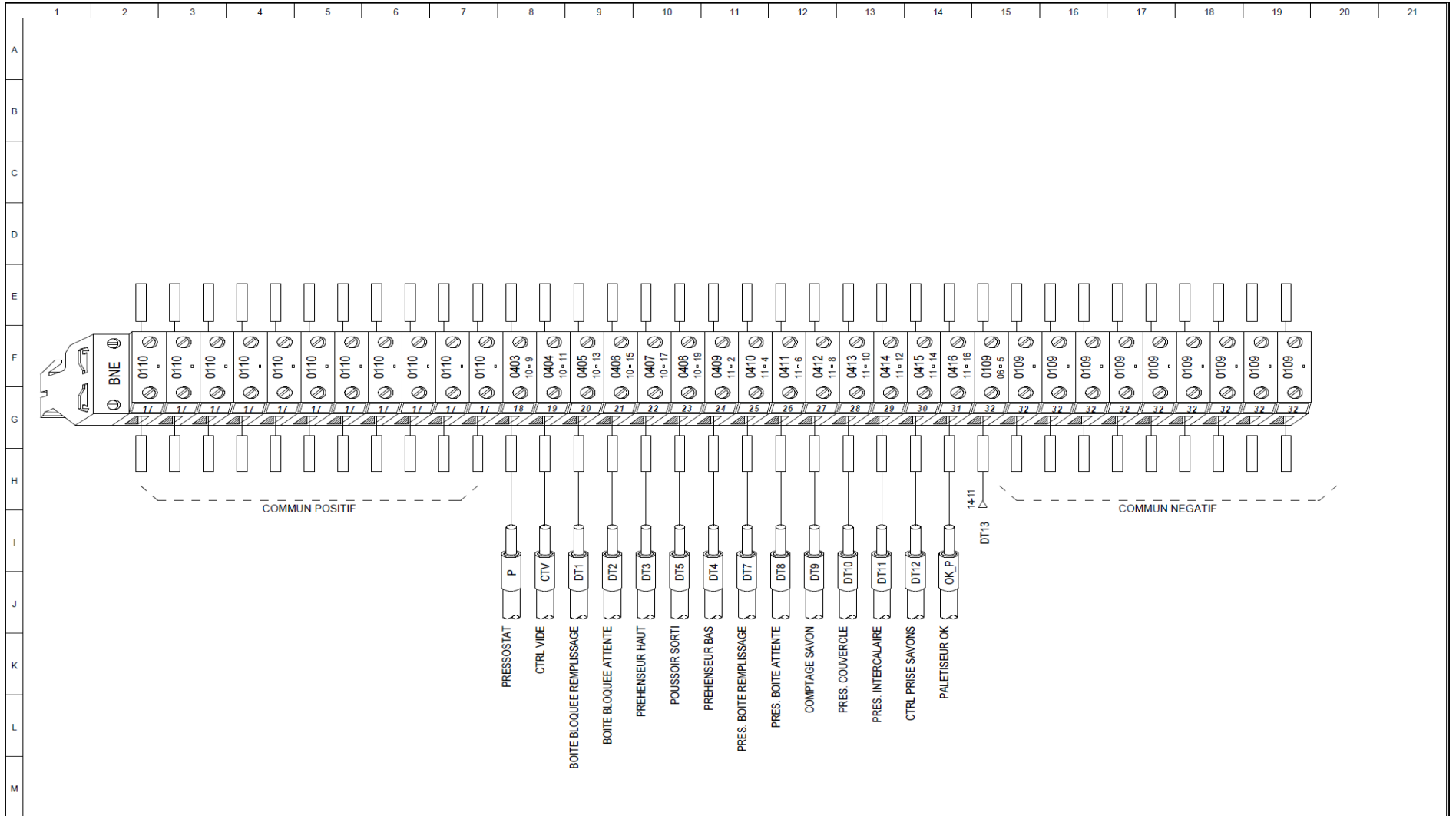

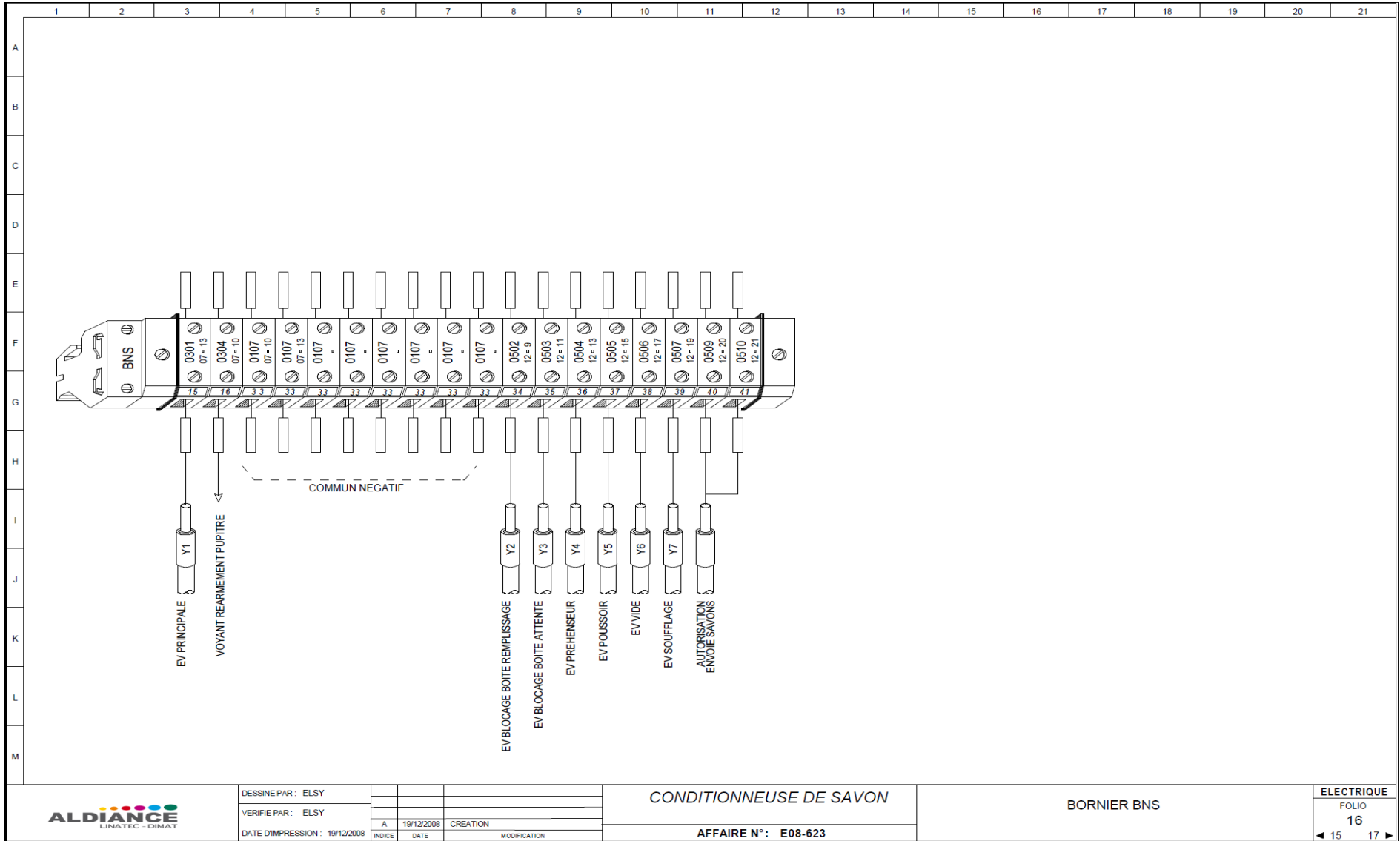

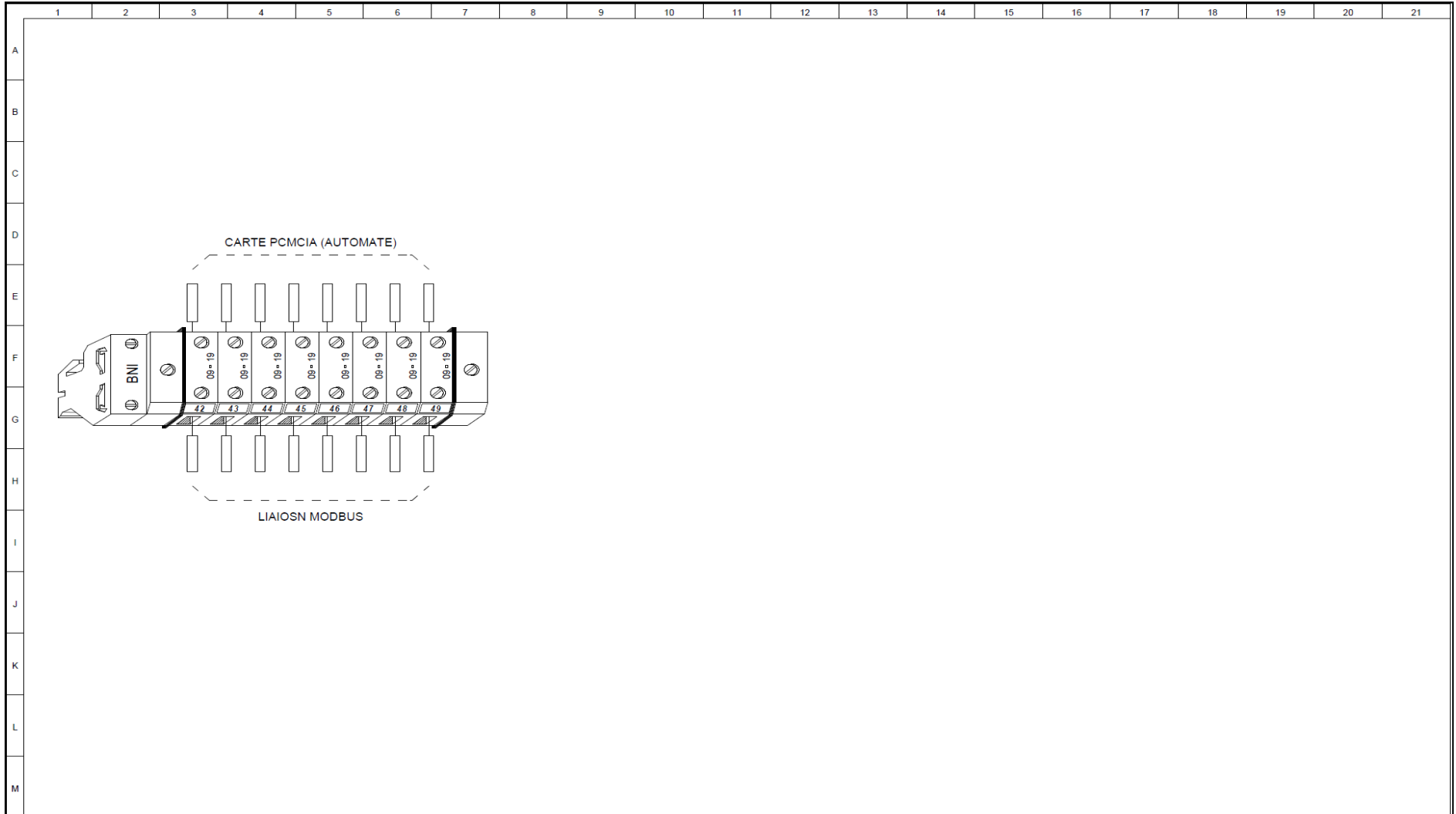

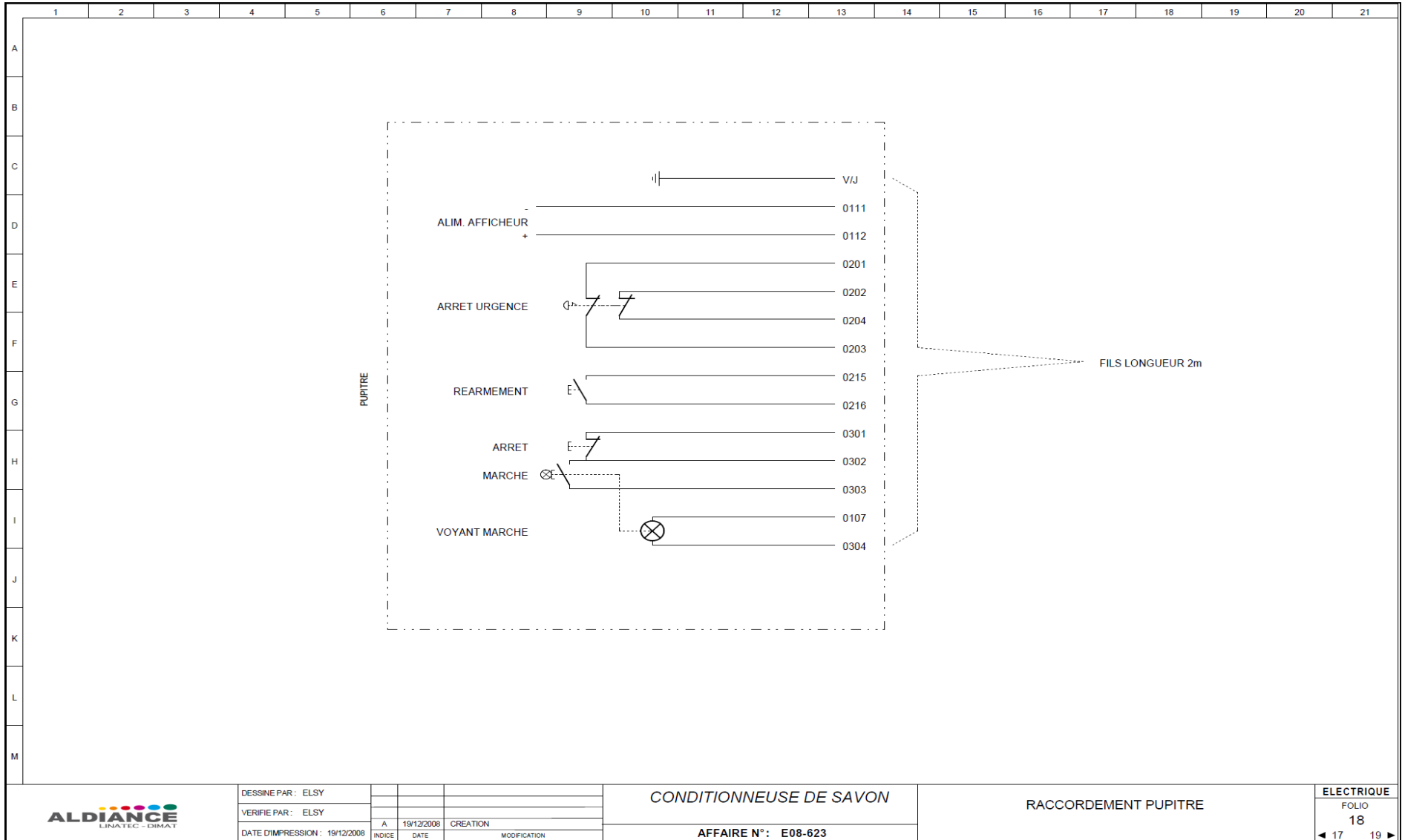

Schémas

PNEUMATIQUE

7. DOSSIER TECHNIQUE PNEUMATIQUE

7.1. SCHEMA

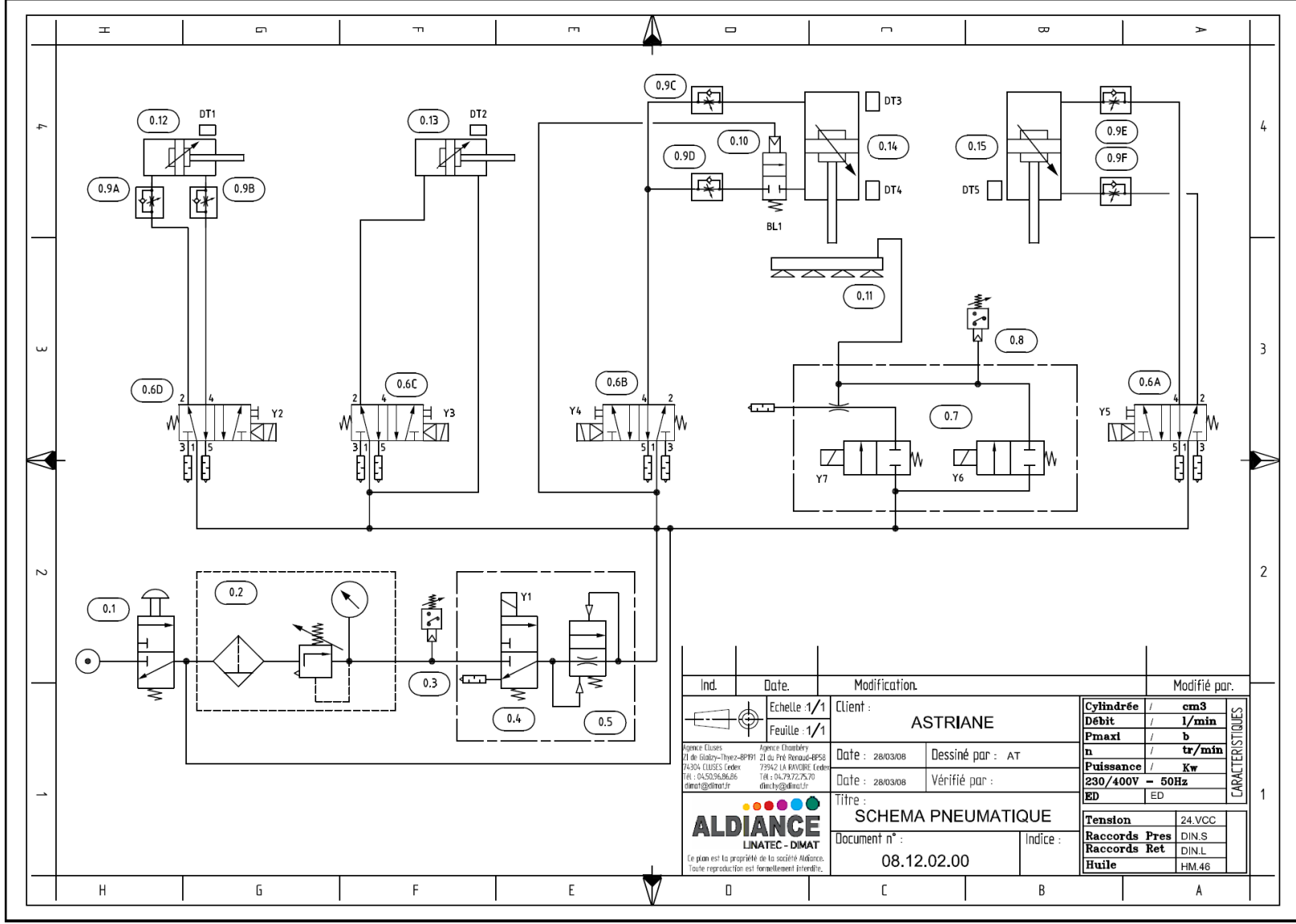

Ind.	Date.	Modification.	Modifié par.
	Echelle : 1/1	Client : ASTRIANE	
	Feuille : 1/1	Date : 28/03/08	Dessiné par : AT
Agence Cluses ZI de Glazay-Thyez-BP111 73304 CLUSES Cedex Tél : 04.50.26.86.26 dimat@dimat.fr		Agence Charlebray ZI du Pré Renaud-BP58 73542 LA RAVOIRE Cedex Tél : 04.78.72.75.70 dteub@dimat.fr	
ALDIANCE LINATEC - DIMAT <small>Le plan est la propriété de la société Aldiance. Toute reproduction est formellement interdite.</small>		Date : 28/03/08	Vérifié par :
Titre : SCHEMA PNEUMATIQUE		Document n° : 08.12.02.00	Indice :
Caractéristiques :		Caractéristiques :	
Cylindrée	/	cm3	
Débit	/	l/min	
Pmaxi	/	b	
n	/	tr/min	
Puissance	/	Kw	
ED	ED	230/400V - 50Hz	
Tension	24.VCC		
Raccords Pres	DIN.S		
Raccords Ret	DIN.L		
Huile	HM.46		